



文件修订履历

Version	Amended content	Amended page	Amended date
1.0	Original		
1.1	Battery pack dimension; New drawing of battery pack with white spacer on the bottom of the battery and design of drawstring; New design of label; New drawing of battery pack	3 10 11 12	2013.05.22
1.2	New drawing of battery	10	2013.07.29
1.3	New drawing of battery	10	2013.08.02
1.4	New design of label	11	2013.08.31



Specification of Li-ion Rechargeable Battery

Model No.: BAK-763448A-PACK

Reported by: 陈声雨 Date: Jul,26,2013

Checked by: 刘永硕 Date: Jul,26,2013

Approved by: 陈 军 Date: Aug,02,2013

1. Scope

This specification describes the definition, technical requirement, testing method, warning and caution of the Lithium ion rechargeable battery. The specification only applies to SHENZHEN BAK's Li-ion battery.

2. Product Model

2.1 Battery type: Lithium ion rechargeable battery pack

2.2 Model No.: BAK-763448A-PACK

3. Basic Specification

3.1	Nominal voltage	3.7V
3.2	Capacity	1300mAh (0.2C discharged from 4.2V to 2.75V)
3.3	Charge voltage	4.20±0.05V
3.4	Standard charging current	0.2C
3.5	Max charging current	1C
3.6	Charge conditions	CC / CV
3.7	Standard constant discharging current	0.2C
3.8	Max continuous discharging current	1.0C
3.9	Discharge cut-off voltage	2.75V±0.05V
3.10	Internal Impedance	≤150mohm (after charged)
3.11	Working temperature	Charge: 0 ~ +45℃
3.12		Discharge: -20 ~ +60℃
3.13	Storage temperature	-20 ~ +45℃ <recommend -0~35℃>
3.14	Relative humidity	65±20%
3.15	Weight	Approx 36g <for battery pack>
3.16	Battery pack dimension	Thickness: 7.90mm±0.2mm
		Width : 38.0mm±0.2mm
		Length : 53.6mm±0.2mm

4. Visual Inspection

There shall be no such defects as remarkable scratches, cracks, bolts, cup cancers, deformations, swelling, leakage.

5. Detailed Specification

5.1 Electrical specification

Items	Test conditions	Results
5.1.1 Full charge <standard charge>	Under 20±5 to 4.2V with constant current of 0.2 C ₅ mA, and then, charged continuously with constant voltage of 4.2V until the charged current is less than 0.02 C ₅ mA.	Remark: it is standard charge method
5.1.2 Rated capacity	Under 20±5 °C charge the cell according to above charging method, then, keep it for 0.5-1hrs. Discharge the cell with constant current 0.2C ₅ mA to 2.75V, the discharging time is not less then 5 hours.	≥1300mAh
5.1.3 Cycle life	Discharge the cell with constant current 0.2C ₅ mA to 2.75V firstly, then, charged it for 2.5hrs by quick charging, keep it for 30mins. Discharge it with current 1C ₅ mA to 2.75V, this is one cycle. To do the cycle test for 300 [†] times.	Capacity ≥ at least 80% of the rated capacity
5.1.4 Internal impedance	At 1kHz AC with fully charge state	Initial battery pack ≤ 150m Ω
5.1.5 Temperature performance	Hi-temperature: At 20±5 charge, then, keep it in the oven of 55±2 with constant current of 0.5 C ₅ mA to 2.75V, the discharging time should be not less than 51 minutes.	
	Low temperature: At 20±5 charge, then, keep it in the oven of -20±2 °C for 16 hrs. Discharge the cell with constant current 0.2 C ₅ mA, the discharge time should be not less than 3hrs.	
	Constant temperature & humidity: At 20±5 according to standard charge, then, keep it in 40±2 48hrs, after this, keep the cell in 20±5 °C with constant current of 0.5 C ₅ mA to 2.75V, the discharge time should be not less than 36mins.	
5.1.6 Storage	Storage for 28 days at 25°C.	Capacity ≥80%
	Storage for 7 days at 60°C.	Capacity ≥85%
5.1.7 Open circuit voltage	As of shipment	3.7 – 4.0V

6.1 Mechanical specification

Items	Test conditions
6.2.1 Vibration test	At 20±5 standard charge. Then, vibrated it 10 times in each direction of X, Y, Z with changing frequency of 10~55HZ and amplitude of 0.35mm, the rate of scan frequency is from 10~55HZ per min. After above test, to keep the battery at 20±5 30mins, the battery cannot be break, scratch, distortion, contamination and leakage, and the Voltage is not less than 3.6V.
6.2.2 Free fall testing	At 20±5 °C charge the cell by standard charging, then drop it freely for six times in each direction of X, Y, Z from the height of 1000mm onto the hard board with the thickness of 20mm. After above testing, to keep the cell at (20±5) °C for 1-2hrs, the cell cannot be break, scratch, distortion, contamination and leakage. Discharge the cell to 2.75V with constant current 0.2 C ₅ mA, it should be discharged and the discharge time should be not less than 51 minutes.

6.3 Secure Specification

Items	Test conditions
6.3.1 Impact Testing	At 20±5 °C fully charge the cell, place the cell on the impact flat, a 10kgs weight dropped from 1m height onto cell, distortion is allowed. After above testing, to keep the battery at 20±5 °C for 2hrs, the cell should be not exploded or catch fire.
6.3.2 Heat impact testing	Put the cell into a air oven, the temperature in the oven should rise at the rate of speed of (5±2 min, the cell should be not explosion, fire or fume.
6.3.3 Short-circuit test	At 20±5 °C fully charge by max resistance of 50mΩ by connecting the positive and negative terminals of cell with copper wire, Monitor its temperature while testing, finish the test when the cell case temperature was 10°C lower than the peak temperature. The cell should be not explosion, fire.
6.3.4 Over-charged test	Connect the cell with a CC/CV power, then, charge the cell to 4.6V with constant 3A current, and last for 2hrs. The cell shall be not explode and fire.
6.3.5 Over-discharged test	At 20±5 with constant current 0.2 C ₅ mA to 2.75V. Connected with external load of 30Ω for 24hrs. The cell shall be not explode or fire.

7. Test Conditions

Temperature : 25±2°C

Relative humidity : 65±20%

8. Warranty

The period of validity of the cell is 12 months.

9. Warnings

9.1 Warning:

To prevent the possibility of the battery from leaking, heating and explosion. Please observe the following precautions:

- Don't immerse the battery in water and seawater. Please put it in cool and dry environment if no using.
- Do not use and leave the battery near a heat source as fire or heater.
- Being charged, using the battery charger specifically for that purpose.
- Don't reverse the positive and negative terminals.
- Don't connect the battery to an electrical outlet directly.
- Don't discard the battery in fire or heater.
- Don't connect the positive and negative terminal directly with metal objects such as wire.
- Do not transport and store the battery together with metal objects such as necklaces, hairpins.
- Do not strike, throw or trample the battery.
- Do not directly solder the battery and pierce the battery with a nail or other sharp object.

9.2 Caution:

- Do not use or leave the battery at very high temperature conditions (for example, strong direct sunlight or a vehicle in extremely hot conditions). Otherwise, it can overheat or fire or its performance will be degenerate and its service life will be decreased.
- Do not use it in a location where is electrostatic and magnetic greatly, otherwise, the safety devices may be damaged, causing hidden trouble of safety
- If the battery leaks, and the electrolyte get into the eyes. Do not wipe eyes, instead, rinse the eyes with clean running water, and immediately seek medical attention. Otherwise, eyes injury can result.
- If the battery gives off an odor, generates heat, becomes discolored or deformed, or in any way appear abnormal during use, recharging or storage, immediately remove it from the device or battery charge and stop using it.
- In case the battery terminals are dirt, clean the terminals with a dry cloth before use. Otherwise power failure or charge failure may occur due to the poor connection with the instrument.
- Be aware discharged batteries may cause fire; tape the terminals to insulate them.

10. Data sheet for PCB

10.1. Performance test Parameter

Main parameter Topt=25°C			
Item	Symbol	Description	Standard <according to IC>
Over-charge protection	VDET1	Overcharge detection voltage	4.28±0.025V
	tVDET1	Delay time of Over-charge protection	700~1300ms
Over-discharge protection	VDET2	Over-discharge detection voltage	2.3±0.05 V
	tVDET2	Delay time of Over-discharge protection	14~26ms
	IDP	Over-current detection current	2.0~6.0A
	tVDET3	delay time of over-current test	8~16ms
			Renew from protection
Short-circuit protect		Protect condition	External short-circuit
	TSHORT	Delay time of tes	230~500us
		Renew condition from protection	Disconnect short-circuit
Resistance	RDS	State of main circuit connection	Vc=4.2V;RDS≤70mΩ
Self-discharge current	IDD	Under normal working condition	4.0uA Type 8.0uA Max

10.2 PCM BOM list:

No.	Code	Name	SPEC	Assembling method	Unit	QTY
1	U1	Control IC	R5402N-110KD	SOT-23-6	PC	1
2	U2	MOSFET	UPA1870	TSSOP-8	PC	1
3	R1	SMD Resistor	330Ω ±5% SMD	0603	PC	1
4	R2	SMD Resistor	1KΩ ±5% SMD	0603	PC	1
5	R3	SMD Resistor	75KΩ ±5% SMD	0603	PC	1
6	R4	SMD Resistor	47KΩ NTC ±5% SMD B value 3950K 3%	0603	PC	1
7	C1	SMD Capacitor	0.1 μ F -20/+80% 25V	0603	PC	1
8	PCB	board	35.1*5.8*0.5mm		PC	1

10.3 Drawing of PCM SCREEN SILK:

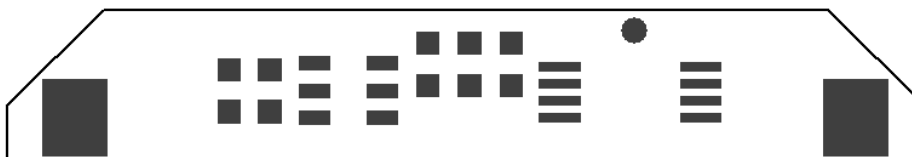
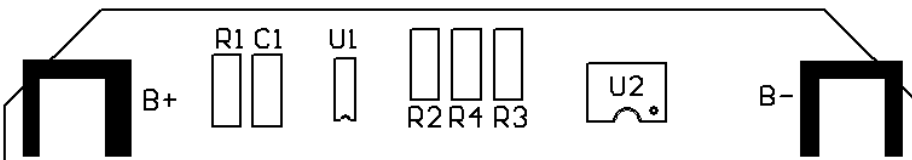
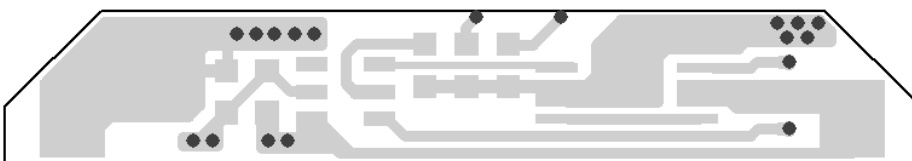
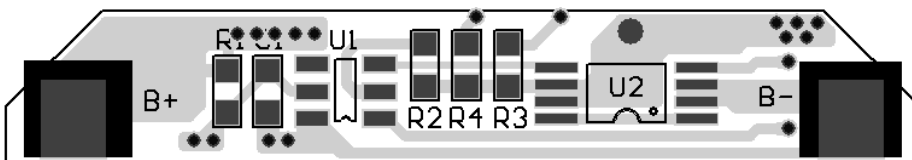

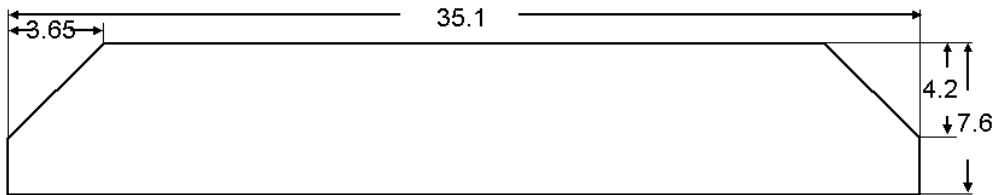
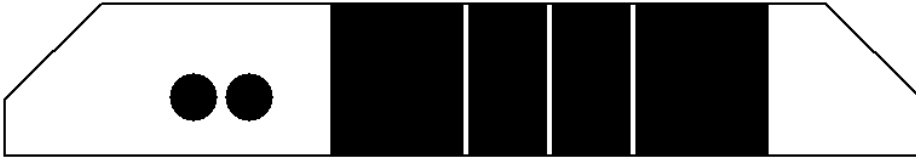
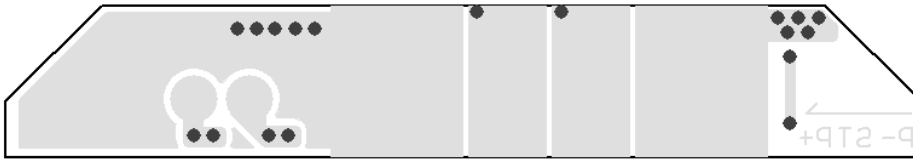

10.4 Drawing of PCM SCREEN SILK:

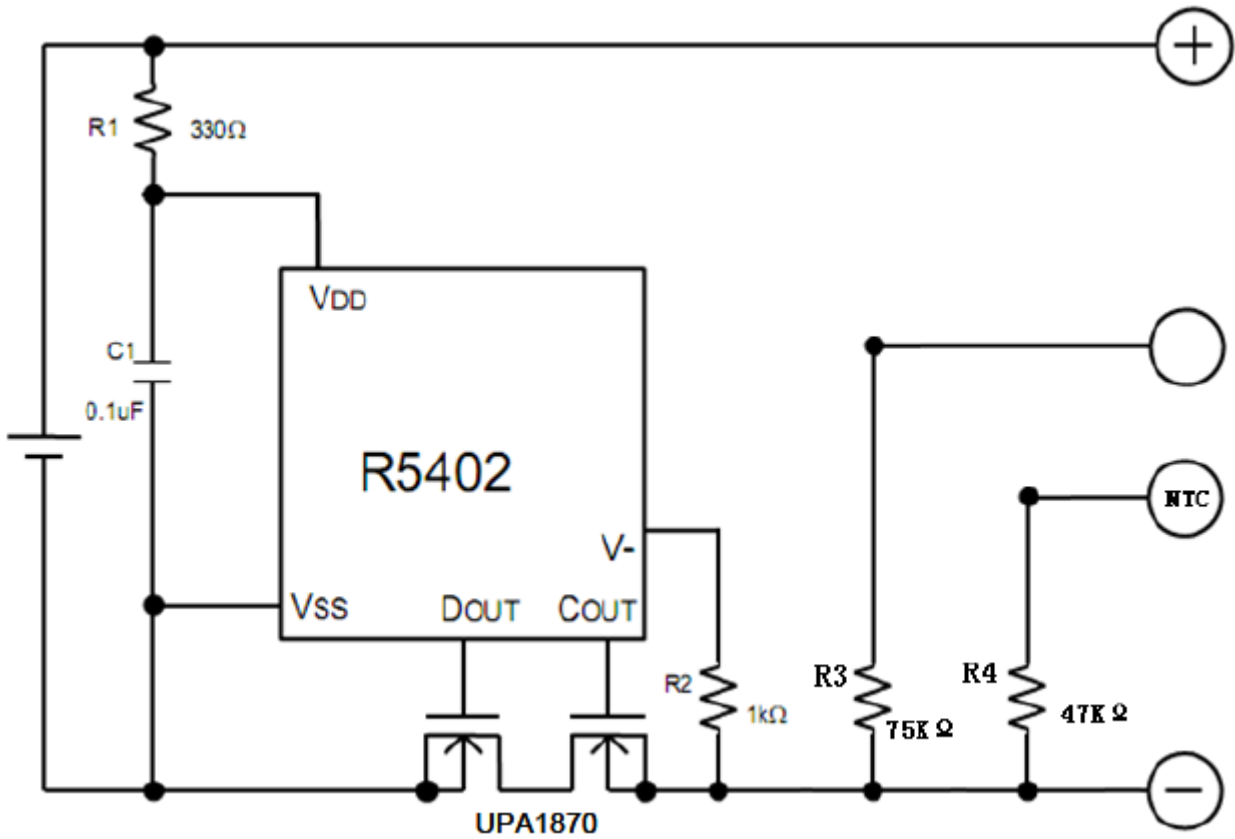

11. Drawing of battery pack: BAK-763448A-PACK

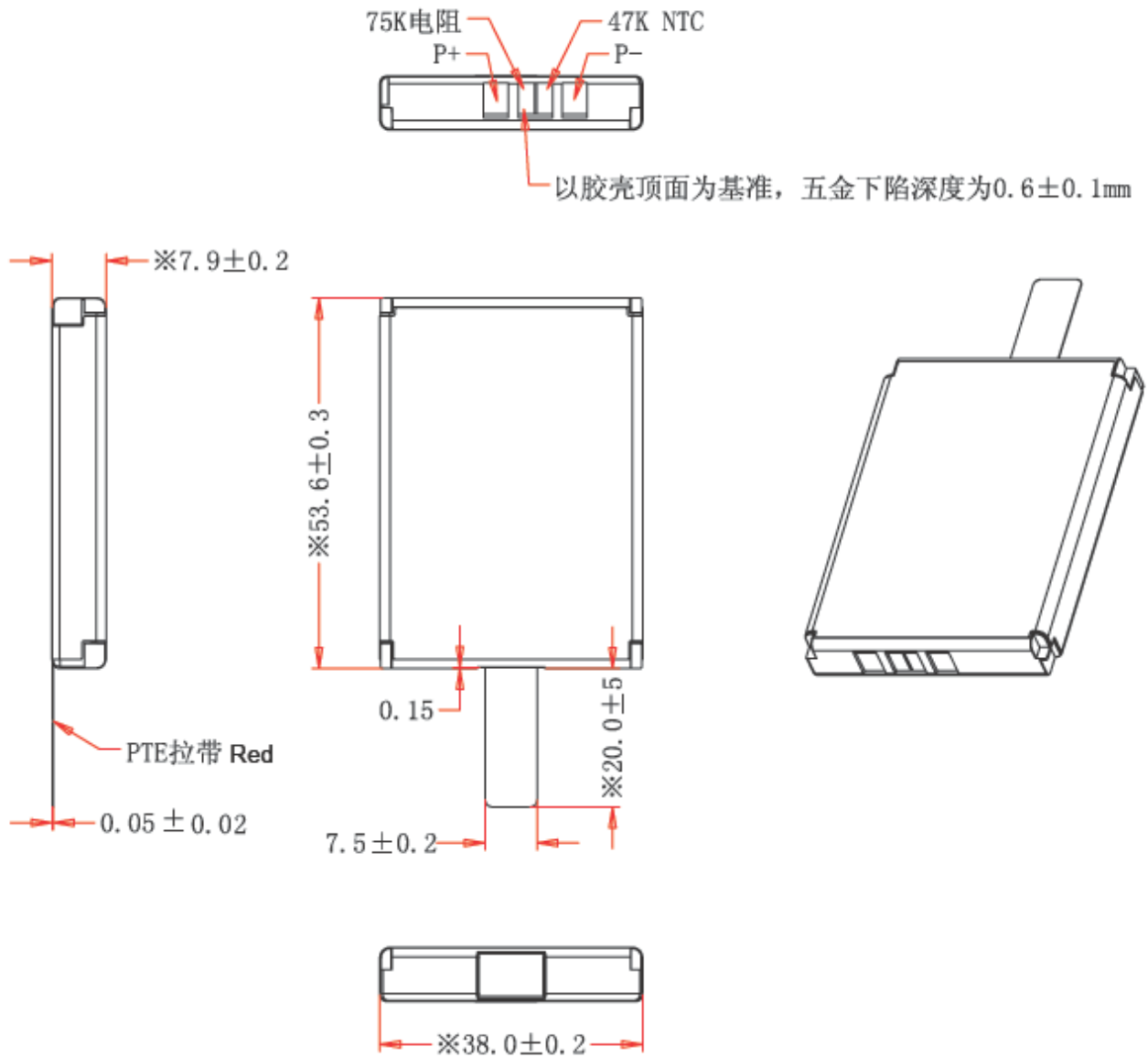

12. Drawing of battery label.

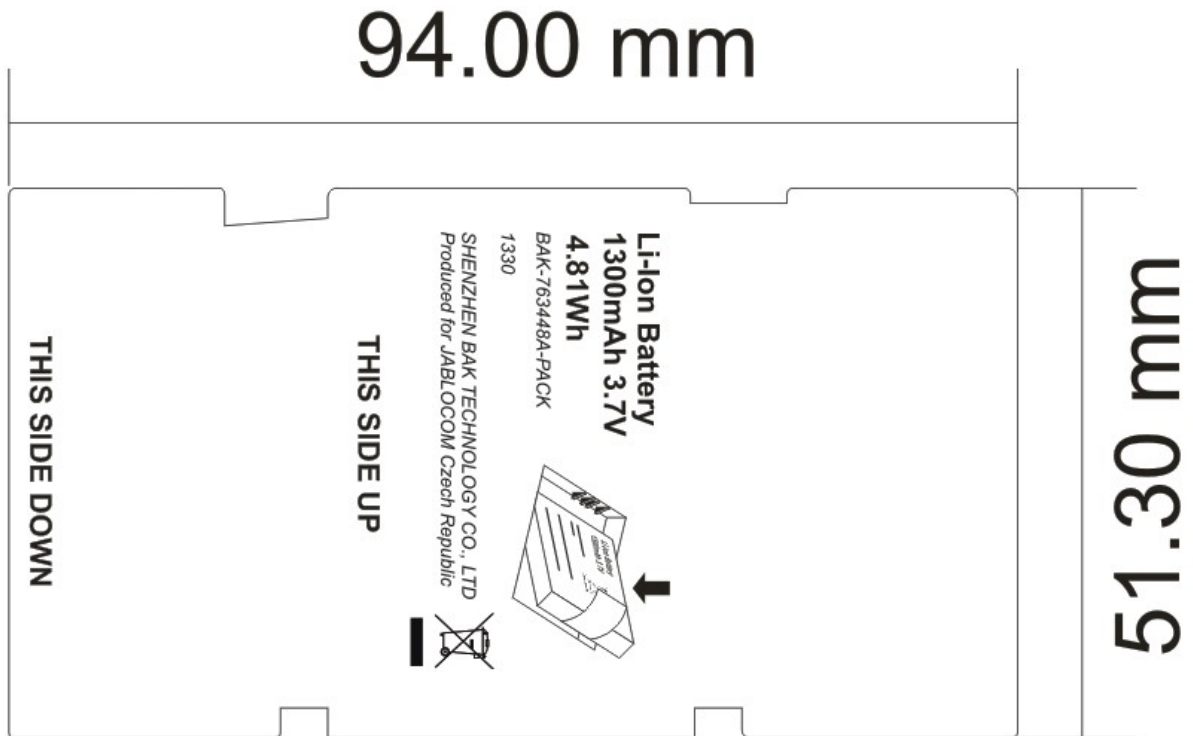

YY: year of production in 2 digit format (for example year of 2011 = 11)

WW: week of battery production

13. Drawing of battery packing.

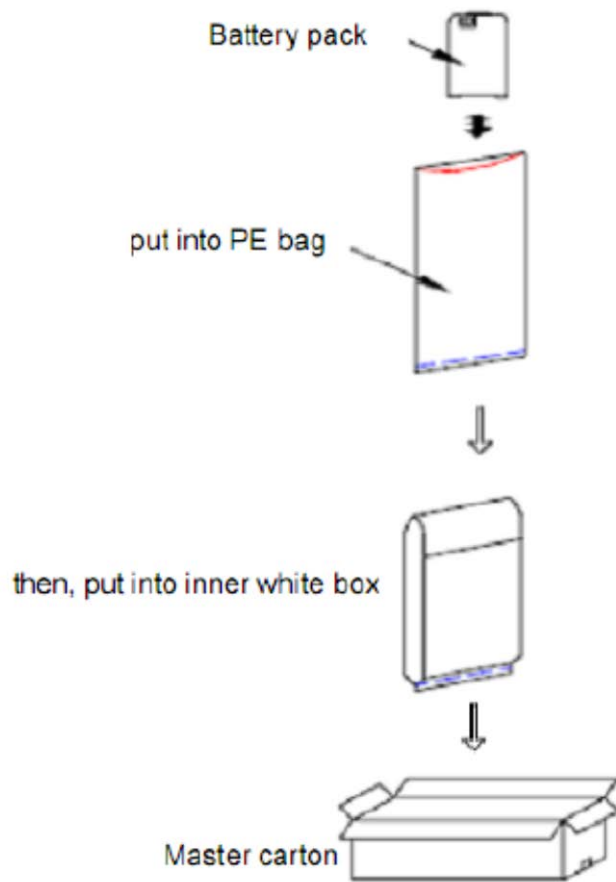

Remark: 200pcs per carton, approx 7.5kgs/CTN,

carton dimension: 37.6*33.6*14.5<mm>