

JA-80K “Oasis” Control panel installation manual

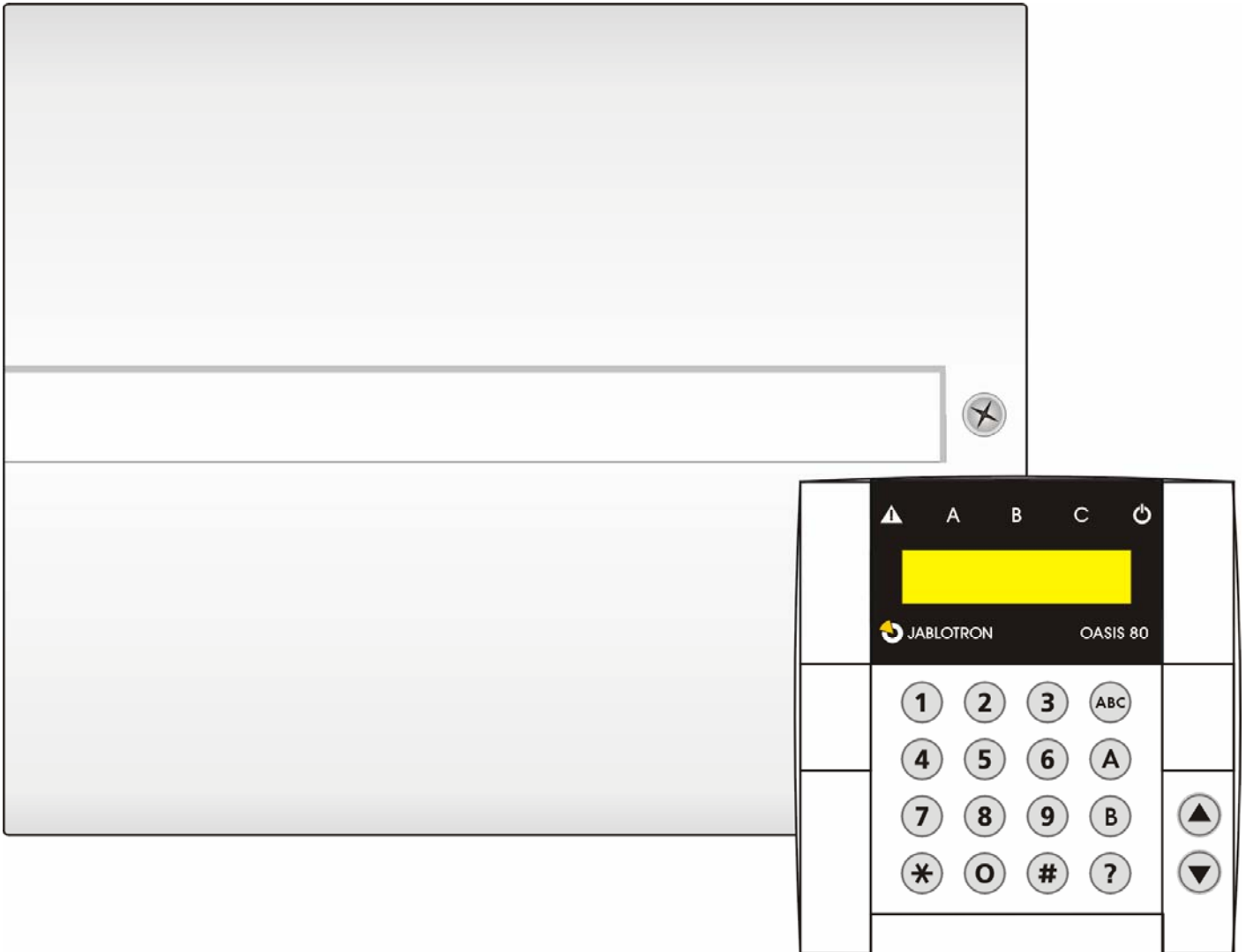

*This manual is valid for control panel JA-80K version KE60108 (printed on internal circuit board).
The control panel can be configured by a PC running ComLink software - version 80 or higher.*

Contents:

1. CONTROL PANEL ARCHITECTURE.....	3		
1.1. OPTIONAL SYSTEM CONFIGURATIONS	4		
2. INSTALLATION	4		
2.1. POWER INLET	4		
3. CONTROL PANEL MEMORY UNIT	4		
4. CONTROL PANEL CONNECTORS AND TERMINALS	4		
5. WIRED KEYPAD CONNECTION.....	5		
6. BACK-UP BATTERY	5		
7. POWERING-UP THE CONTROL PANEL FOR THE FIRST TIME.....	6		
7.1. WIRELESS KEYPAD ENROLLMENT	6		
8. LANGUAGE SELECTION OF THE KEYPAD.....	6		
9. RESETTING THE CONTROL PANEL	6		
10. CLOSING THE CONTROL PANEL COVER	6		
11. ENROLLING WIRELESS DEVICES.....	6		
11.1. INSTALLING WIRELESS DEVICES	6		
11.2. ENROLLING WIRELESS DEVICES TO THE CONTROL PANEL	6		
11.3. TESTING ENROLLED DEVICES.....	7		
11.4. MEASURING SIGNAL STRENGTH	7		
11.5. ERASING ENROLLED DEVICES	7		
11.6. ENROLLING THE CONTROL PANEL TO UC AND AC MODULES	7		
12. CONTROL PANEL PROGRAMMING	8		
12.1. CONTROL PANEL PROGRAMMING SEQUENCES	8		
12.2. EXIT DELAY TIME	10		
12.3. ENTRANCE DELAY TIME	10		
12.4. ALARM DURATION TIME	11		
12.5. PGX AND PGY FUNCTIONS.....	11		
12.6. CHANGING TELEPHONE NUMBERS IN MAINTENANCE MODE.....	11		
12.7. RADIO INTERFERENCE INDICATION	11		
12.8. RADIO COMMUNICATIONS SUPERVISION	11		
12.9. RESET ENABLED	11		
12.10. ENROLLMENT TO A SUB CONTROL PANEL FOR SETTING (ARMING)	11		
CONTROL			
12.11. MASTER CODE RESET	12		
12.12. CONTROL PANEL ENROLLMENT TO UC OR AC MODULES OR TO A SUB	12		
CONTROL PANEL			
12.13. SETTING (ARMING) WITHOUT AN ACCESS CODE.....	12		
12.14. TRIGGERED-DETECTOR INDICATION	12		
12.15. CONFIRMATION OF INTRUDER ALARMS	12		
12.16. EXIT DELAY BEEPS.....	12		
12.17. EXIT DELAY BEEPS WHILE PARTIALLY SETTING (ARMING)	13		
12.18. ENTRANCE DELAY BEEPS.....	13		
12.19. SETTING (ARMING) CONFIRMATION BY WIRED-SIREN CHIRP	13		
12.20. SIRENS ALWAYS SOUND DURING AUDIBLE ALARMS	13		
12.21. WIRELESS SIREN ALARM ENABLED (IW AND EW)	13		
12.22. AUTO-BYPASS USER APPROVAL VIA THE <input type="checkbox"/> KEY	13		
12.23. FINAL-DOOR DETECTORS.....	13		
12.24. PARTIAL SETTING (ARMING) OR SYSTEM SPLITTING	14		
12.25. AUTOMATIC SUMMER TIME (DAYLIGHT SAVING TIME)	14		
12.26. TAMPER ALARM IN RESPONSE TO AN INCREASE IN THE NUMBER OF	14		
TRIGGERED TAMPER SENSORS	14		
12.27. OPERATING THE PG OUTPUTS USING <input type="checkbox"/> 8 AND <input type="checkbox"/> 9	14		
12.28. PERMANENT ALARM STATUS DISPLAY FOR A SET SYSTEM	14		
12.29. TAMPER ALARM IF UNSET.....	15		
12.30. ENGINEER RESET	15		
12.31. RECORDING PG OUTPUT ACTIVATION TO MEMORY	15		
12.32. ANNUAL CHECK NOTIFICATION.....	15		
12.33. ONLY SINGLE ALARM INDICATION	15		
12.34. SETTING (ARMING) BY SERVICE CODE	15		
12.35. AUDIBLE PANIC ALARM	15		
12.36. HIGHER CONTROL-PANEL RECEIVER-SENSITIVITY	15		
12.37. ACCESS BY CODE PLUS CARD	16		
12.38. AUDIBLE 24 HOUR INTRUDER ALARM.....	16		
12.39. SERVICE MODE ONLY WITH SERVICE CODE AND MASTER CODE.....	16		
12.40. DEVICE REACTIONS AND SECTION ASSIGNMENT.....	16		
12.41. CODE/CARD REACTIONS AND SECTION ASSIGNMENT	17		
12.42. ENROLLMENT BY KEYING IN PRODUCTION CODES	17		
12.43. AUTOMATIC SETTING/UNSETTING SCHEDULE.....	17		
12.44. CHANGING THE SERVICE CODE.....	17		
12.45. GO TO MAINTENANCE MODE.....	17		
12.46. SETTING THE INTERNAL CLOCK.....	17		
12.47. EDITING KEYPAD TEXT.....	18		
13. OPERATING THE SYSTEM.....	18		
13.1. THE SYSTEM KEYPAD.....	18		
13.1.1. Keypad indicators.....	18		
13.1.2. LCD display.....	18		
13.1.3. Keypad display sleep-mode	18		
13.1.4. Keys.....	18		
13.1.5. Functions beginning with the <input type="checkbox"/> <input type="checkbox"/> key	19		
13.2. PROGRAMMING ACCESS CODES AND CARDS	19		
13.2.1. Programming access codes and cards.....	19		
13.3. SETTING AND UNSETTING (ARMING/DISARMING) THE SYSTEM	20		
13.4. MAINTENANCE MODE	20		
		13.4.1. Displaying which user/card positions are occupied.....	20
		13.4.2. Bypassing devices.....	20
		13.4.3. Protecting a car near the system	20
14. OPERATING AND PROGRAMMING THE SYSTEM BY PC.....	21		
15. BASIC GUIDANCE FOR INSTALLERS	21		
16. TROUBLE-SHOOTING.....	22		
17. CONTROL PANEL TECHNICAL SPECIFICATIONS	22		

System installation shall only be undertaken by qualified technicians holding a training certificate issued by an authorized distributor. The manufacturer cannot be held responsible for any damage or consequences related to the improper or incorrect use of this product.

1. Control panel architecture

- The control panel has **50 addresses** (01 to 50), meaning that up to 50 wireless devices can be enrolled i.e. detectors, keypads, keyfobs, sirens etc.
- When triggered, a detector sends a so-called natural signal which dictates what the reaction of the control panel should be. E.g. the natural signal of a door contact or PIR detector can be an instant or delayed alarm which is selectable by a DIP switch inside the detector. A keyfob, for instance, sends signals for set (arm), unset (disarm) and panic.
 - The control panel is factory-set to perform natural reactions according to the signals sent from wireless devices. By programming the addresses of the devices in the control panel, it is possible to define how the control panel reacts to individual wireless devices. E.g. a door detector assigned to address 15 could trigger a panic reaction, and a keyfob button using address 24 could cause a fire reaction etc.
- Wireless devices can be assigned to 3 sections: **A, B** or **C**. Assignments to sections either have an effect when partial setting is used e.g. only A is set, AB is set, or ABC is set (which, for example, would be suitable for homes where A could mean afternoon setting, AB night setting and ABC total setting), or if the system was split into two independent partitions A and B, with a common section C. In the second case, each A or B section can be set individually, and C is automatically set when both A and B have been set by users. This would be suitable for two independent families in a single house, or two companies in one building.
- There are two hard-wired inputs with programmable functions assigned to addresses 01 and 02. If these two inputs are not used, the two addresses can be used to enroll wireless devices. Hard-wired inputs are also provided by some wireless devices, such as keypads, door detectors, and PIR movement detectors.
- The control panel has two alarm outputs: **IW** = internal (indoor) warning and **EW** = external (outdoor) warning. Both these signals are also available as wireless signals.
- There are two programmable outputs in the control panel, **PGX** and **PGY** whose functions can be configured. The PG outputs are not only available as physical control-panel terminals, but also as radio signals for the control of UC and AC receiver outputs.
- The system can be operated by user codes or user cards. The system can recognise up to 50 different users. The system can also be operated by wireless keyfobs, and if the control panel is equipped with a suitable communicator it can also be remotely controlled by mobile phone or the Internet.
- It is possible to program different reactions to access codes or access cards and if the system is split, it is possible to program which part of the building is accessible by a particular code or card. Each of the possible 50 users can have his own 4-digit access code and/or access card. Setting (arming) and unsetting (disarming) is possible by card or code, and if a higher security level is needed it is possible to make it compulsory to confirm the validity of a card by code entry.
- **Programming the system** is possible by Oasis keypads such as the wireless JA-80F or the hard-wired JA-80E, and also by computers running ComLink software. Further options offer programming by mobile phone or the Internet.
- There is a power supply in the control panel and space for a **12V, 1.3 to 2.6 Ah** back-up battery.
- To connect a hard-wired keypad or a computer, the control panel is equipped with a digital bus provided by terminals and RJ connectors.
- The control panel can be equipped with an optional communicator to provide external communications to the system. The JA-80Y GSM/GPRS communicator or JA80-V LAN and phone line communicator both allow data to be

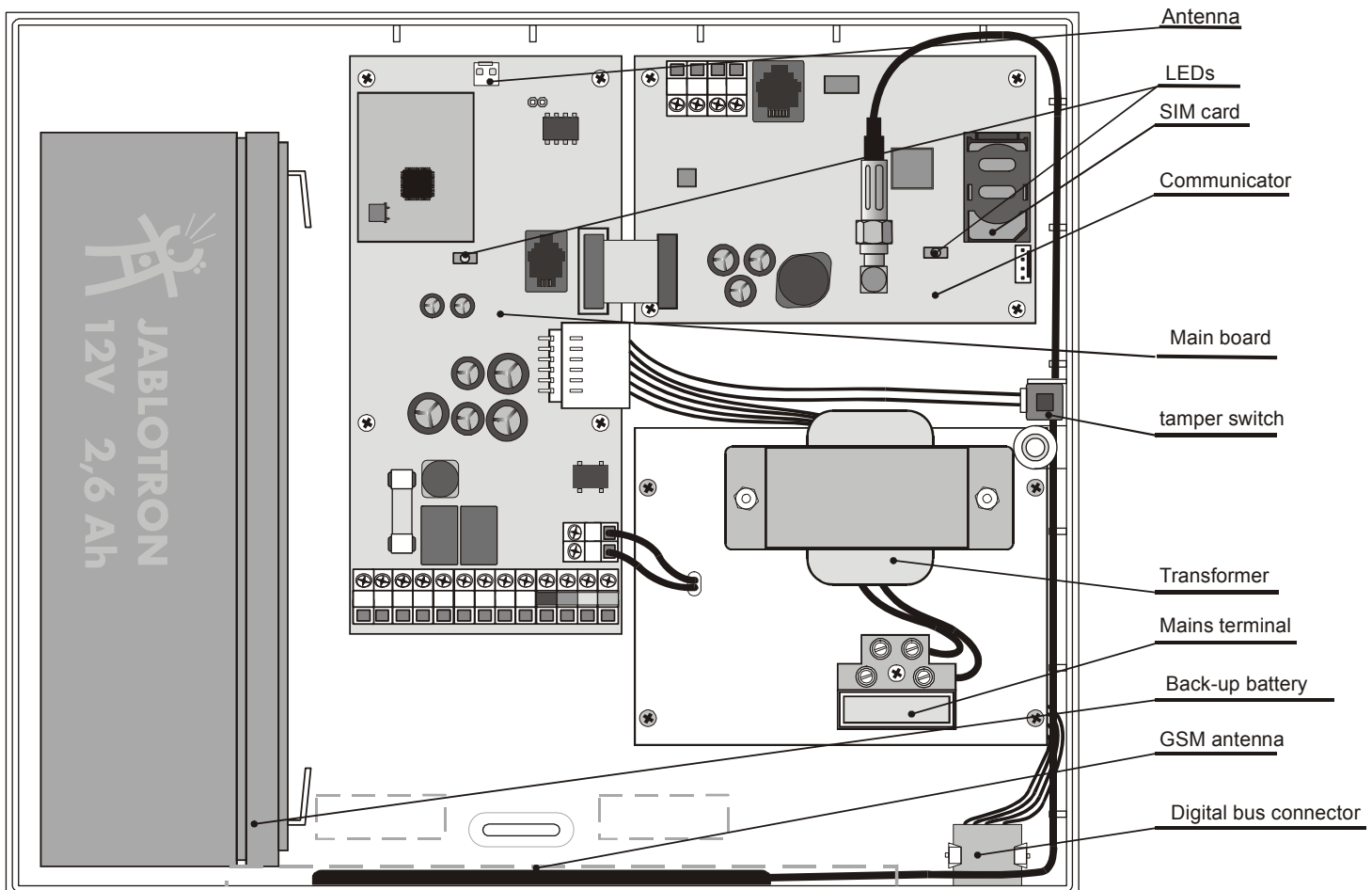

sent to alarm receiving centres (central monitoring stations). They can notify the user using SMS reports and allow remote control and programming of the system by mobile phone and the Internet. Another option is the JA-80X communicator which reports alarms via a traditional phone line using voice messages.

Note: The Oasis JA-80 system has three modes: **operating mode, maintenance mode and service mode.** Operating mode is for the day-to-day use of the system by all authorised users, e.g. setting/unsetting (arming/disarming). Maintenance mode is for the holder of the master code (system administrator) to have limited programming of the system, e.g. changing codes/cards, bypassing and is inaccessible to all other users. Service mode is only for installers and is used to program and control all aspects of the system.

1.1. Optional system configurations

In the European Union region, follow the valid standards and rules, especially series EN-501-xx. The Oasis control panel complies with grade 2.

The control panel must have one of the following configurations as a minimum:

- At least two non-backup-battery sirens (JA-80L or SA-105) + communicator class ATS2 (JA-80Y, JA-80V or JA-80X)
- At least one backup-battery siren (JA-80A or OS-360/365/300) + communicator class ATS2 (JA-80Y, JA-80V or JA-80X)
- No siren + communicator class ATS3 (JA-80Y or JA-80V)

Note: the above-recommended configurations are based on the EU standard EN-50131-1 valid at the time of issuing this manual.

2. Installation

The control panel can be attached to the wall using 3 screws. The drilling template is on the last page of this manual.

- Because the control panel communicates via radio, it should not be installed near any large metal objects capable of shielding radio communication.
- Route cables (power supplies, telephone leads etc.) inside the control panel before tightly screwing in the screws.

2.1. Power inlet

The control-panel power cable should only be installed by a person holding a sufficient electro-technical qualification.

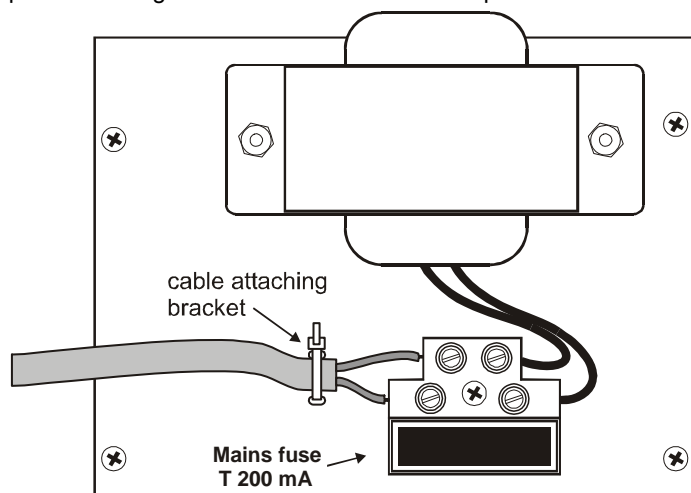

The control panel power supply is double-insulated (safety class 2) and does not incorporate a protective earth wire.

- A double-insulated power cable should be used with a minimum cross-sectional area of 0.75 to 1.5 mm². The power cable should be connected to a switched mains supply fused to 10 Amps.

- In the control panel, connect the cable to the power terminals equipped with a fuse of type T200mA/250V.
- **Fix the cable firmly to the cable holder** in the control panel making sure that the wire ends are properly secured and connected in the terminals.

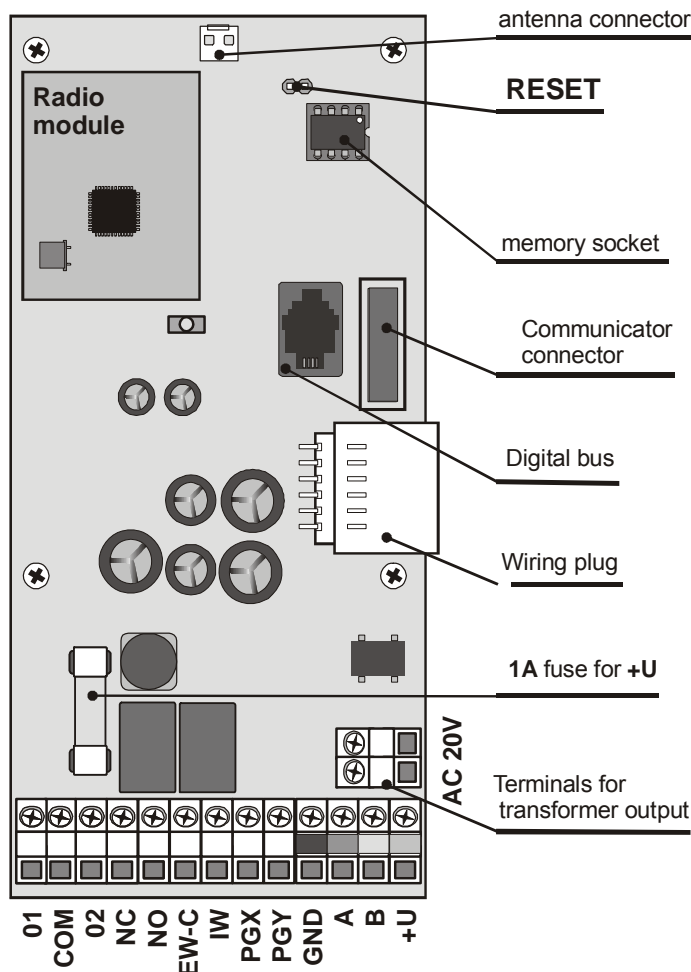

3. Control panel memory unit

The control panel memory unit plugs into its own socket. If, for example, the control panel was damaged, the memory unit could be unplugged and then plugged into another control panel circuit board of the same type to transfer and preserve the settings including enrolled detectors, access codes and cards. The new control panel thereby becomes an exact copy of the former one (a clone).

Notes:

- There are no communicator settings in this memory unit
- Do not connect or disconnect the memory unit while the control panel is powered.
- Although the memory unit is well-protected, in cases of severe damage to the control panel there is a risk that memory contents could be corrupted. It is therefore highly recommended to back-up the settings in a PC using Comlink software.

4. Control panel connectors and terminals

Antenna connector – This is used to connect either to an internal antenna or to external antennas such as the AN-80 or AN-81.

Reset link (normally open) – Used to reset the control panel by shorting the link only while powering up the control panel. This link can also be used to enter control panel enrollment mode by briefly shorting the link while the control panel is powered.

Digital bus connector – for connecting a JA-80E keypad or a PC running Comlink software with a JA-80T interface cable. The same digital bus connector is present on the bottom right hand corner of the plastic housing. Additionally, the same connections are available on the GND, A, B, +U terminals.

Communicator connector – allows the connection of an optional communicator to the main board.

Internal wiring connector – connects the internal wiring in the control panel housing.

Terminals:

AC 20V the transformer output is connected here.

01, GND, 02 are hard-wired inputs for the control panel.

- The reactions to triggering these inputs are determined by the settings of addresses 01 and 02. The factory-set natural reaction for these hard-wired inputs is a delayed alarm in section C.
- Terminals 01 and 02 use resistors in connected double balanced loops to sense loop stand-by, activation or tampering as follows:
 - Connected to GND via a **1 kΩ resistor** = **untriggered** input
 - Connected to GND via **2 to 6 kΩ** = **triggered** input,
 - Connected to GND via **less than 700Ω or more than 6 kΩ** = **tamper signal**
 - Stand-by (untriggered) input zone must have **1 kΩ**
 - Up to five normally-closed door/window contacts can be connected in series to enable one hard-wired input to be used for multiple contacts with each contact having a 1kΩ resistor in parallel (see the diagram below).
 - Multiple normally-closed tamper contacts should be connected in series without any parallel resistors. The number of tamper contacts is unlimited and can be combined with trigger contacts having parallel resistors (see the diagram below).
 - For wiring examples, see the below diagram.

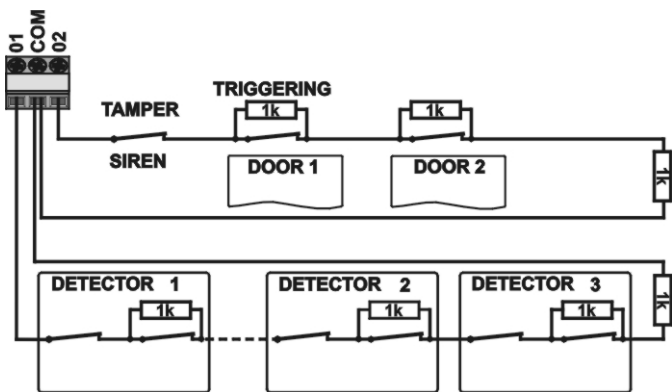

Maximum of 5 detectors in one loop

- If you **enroll a wireless device to address 01 or 02**, the corresponding input terminal **will be disabled**.
- If you do not use an input terminal and you do not enroll a wireless device to its address, then the terminal must be connected to the **GND** terminal via a **1 kΩ** resistor.

NC – normally closed contact for the external warning relay.

NO - normally open contact for the external warning relay.

EWC – common contact for the external warning relay **max. relay contact rating: 1A/60V**. The control panel also transmits the external warning relay signal via radio for wireless sirens.

IW – internal warning (siren) output. This output is grounded during an internal alarm. A standard siren can be wired between terminals +U and IW (**max. 0.5A**). The IW output status is also transmitted by radio for the IW siren.

The main difference between internal and external warning is during the entrance delay period. If any instant detectors are triggered during the entrance delay period, e.g. a child running straight to the living room, only an internal warning will be triggered and an external warning will only follow if the entrance delay has been exceeded.

PGX, PGY – are a pair of terminals providing programmable outputs. If an output is activated it switches to GND with a maximum load of 0.1A/12V. The factory-default setting of PGX is the function ON/OFF which can be operated from the keypad by

the instruction *81 / *80 or using keys ▲ ▼). The factory-default function of PGY is that it will be activated if any section of the system is set. The status of PG outputs is also transmitted by radio for AC and UC output modules.

GND – common ground connection

A,B – digital bus data

+U – back-up power supply (10 to 14V), 1A fuse. Max. continuous load 0.4 A (max. intermittent load 1 A, for 15 minutes, once an hour). If the 1A fuse is blown, the control panel will indicate power supply fault.

5. Wired keypad connection

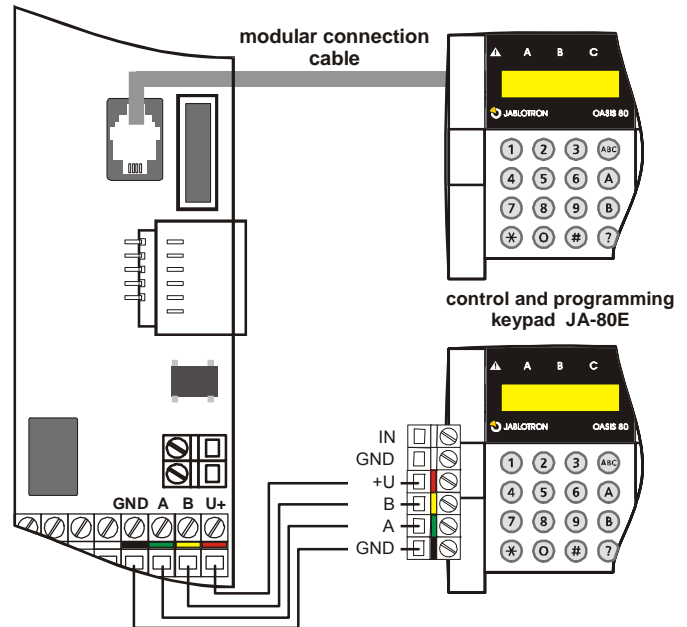

The control panel can be operated and programmed by JA-80F wireless keypads and/or a JA-80E hard-wired keypad. A hard-wired keypad can be connected to the control panel either by flat telephone cable (max. length 10 metres) using RJ connectors, or via twisted-pair cable (max. length 100 metres) connected to the digital bus terminals (GND, A, B, +U).

We recommend only having a single JA-80E hard-wired keypad in the system.

6. Back-up battery

It is possible to use a Jablotron-brand 12V back-up battery in the control panel with capacities of 1.3Ah or 2.6no Ah. The capacity to use depends on the total power consumption of the system and the desired back-up period.

Euro-standard EN 50131-1 specifies a 12 hour minimum back-up time for grade 2 systems. The standby consumption of all system devices is shown in table 1.

Table 1- standby consumption of system devices

Device	mA	Note
Control panel JA-80K	50	No communicator
Keypad JA-80E	30	
Keypad JA-80H (N)	60	Including a WJ-80 interface
Communicator JA-80Y	35	
Communicator JA-80V	30	
Wireless devices are not powered from the control panel.		

- With a **1.3Ah** back-up battery 12 hours of back-up time can be realised if current consumption does not exceed **85mA**. With **2.2Ah** batteries **150mA** should not be exceeded to achieve the same. This only takes 80% of the battery capacity into account as 20% has to be reserved for battery aging effects.
- The average **back-up battery lifetime** is up to **5 years** after which it must be replaced. The back-up battery is automatically charged and its condition is monitored by the system. If the system is being run on only the back-up battery a technical alarm occurs when the battery is nearly discharged. If the voltage gets too low the battery will be

disconnected. After the mains supply has been restored battery charging starts again and the system will begin to function again.

Ensure that the battery is correctly connected (Polarity: RED = positive +, BLACK = negative -).

WARNING – the battery is sold charged – to maintain safety, avoid shorting out the terminals !!!

7. Powering-up the control panel for the first time

- First check all the wiring, and if a GSM communicator is installed, insert its SIM card (PIN code disabled).
- Carefully connect the back-up battery,
- Carefully connect up the mains. A green LED will start flashing on the control panel board.
- If a hard-wired keyboard is connected it will indicate Service mode. If not, the control panel is not set to the factory default and should be reset (see section 9.).

7.1. Wireless keypad enrollment

If no hard-wired keypad is connected to the control panel, and the wireless keypad was not supplied as part of a JK kit, the wireless keypad must be enrolled to the control panel as follows:

1. Have an opened keypad and its battery ready.
2. Check that the green LED in the control panel is flashing.
3. Short the reset link in the control panel for 1 second (e.g. using a screwdriver). This will enter enrollment mode on the control panel.
4. Install batteries into the keypad not far from the control panel.
5. The keypad generates a beep sound and enrolls to address. After that it indicates "Enrollment 04: Device".
6. Press the # key to exit enrollment mode and "Service" will be indicated on the keypad.

Warning:

- If the keypad does not enroll, then the control panel settings are not the factory-defaults. In this case perform a reset and repeat the enrollment procedure.
- If you want to assign the keypad to another address, re-enter enrollment mode via the "1" key, then use the arrow keys to select the desired address. Then disconnect the keypad battery and reconnect it.

Recommendation: it is highly recommended to install the wireless keypad with a magnetic door sensor wired to its hard-wired input terminal. This way the keypad will wake up every time after opening the door and it will produce entrance delay beeps and will be ready to read access cards. It will also save money on a wireless door detector.

8. Language selection of the keypad

If the * key is kept pressed during battery connection, the internal keypad menu will be displayed allowing the selection of the **desired language**. Using the arrows, choose your language and confirm selection by the * key.

In this menu the **door bell function** can also be enabled or disabled (if enabled the keypad makes a sound when its IN input is triggered).

Notes:

- for the JA-80E wired keypad the power can be connected by connecting its cable or by turning on the control panel power
- if the wireless keypad has already had its battery connected, it is necessary to disconnect the battery for a while before pressing and holding the * key
- the language can be selected for each individual keypad in the system (i.e. different keypads can display different languages – for example if foreigners are working in the company)

9. Resetting the control panel

If you need to return the control panel to the factory-default settings perform the following:

1. Disconnect the back-up battery and the mains (for example by removing the fuse from its terminals).
2. **Connect the RESET** link and leave it connected.
3. **Connect the back-up battery and the mains**
4. Wait till the green **LED** starts flashing and then disconnect the **RESET** link

Warning:

- After a RESET, all wireless devices are erased from the control panel and all user codes and access cards are "forgotten".
- After a RESET, the Master code returns to 1234, and the service code to 8080.
- If resetting is disabled (see 12.9) it is impossible to reset the control panel.

10. Closing the control panel cover

After the keypad has started working it is possible to close the control panel cover. **Before** this is done, check that the control panel has an antenna connected.

11. Enrolling wireless devices

The control panel has **50 addresses** (01 to 50), allowing the enrollment of up to 50 wireless devices i.e. detectors, keypads, keyfobs, sirens, etc. A wireless device can be assigned to an address by enrollment or by entering its production code (see 12.42).







11.1. Installing wireless devices

Wireless devices can either be installed at their desired locations first and then enrolled to the control panel or vice versa. If there any doubts as to the suitability of device locations for radio communication, temporarily attach the devices (e.g. using adhesive tape) and test radio communication before finalizing installation. Follow the manuals of the particular devices during their installation.

11.2. Enrolling wireless devices to the control panel

1. The control panel should be in **Service** mode. If it is not, then enter *0 service code (factory default: 8080). The control panel must be unset (disarmed).
2. Press the "1" key, enrollment mode will be entered and the first vacant address will be offered. For a new control panel it will be 03.
3. Using the arrows keys ▲ and ▼, you may select the desired address. If the address is already occupied this is indicated by the A indicator being lit.
4. **The device** will enroll to the selected address just after its battery (power) is connected .
5. Enrollment is confirmed by the A indicator and the next vacant address is then offered.
6. By connecting batteries to all devices one after the other they will all be enrolled to the control panel. Press the # key to exit enrollment mode.

Notes:

- If a wireless device is enrolled to address **01** or **02** this will disable the corresponding hard-wired input terminal (if a wireless device is erased from address **01** or **02**, the hard-wired terminal will be re-enabled).
- **Keyfobs type RC-8x** can be enrolled by pressing and holding a pair of buttons simultaneously, i.e.: + or +. (enrollment by battery installation will enroll buttons +). This means that a 4-button keyfob can be enrolled to the

control panel twice but to two different addresses with different features –see 12.40.

- Only a single device can be enrolled to each address.
- When indicator A lights, it means the displayed address is occupied and therefore no more devices can be enrolled to this address.
- If a device has already been enrolled to an address, and it is then re-enrolled to another address, the device's address assignment will change from the original address to the new one.
- If a device cannot be enrolled to the control panel, either it does not have a good wireless connection to the control panel possibly due to excessive distance or it could be too close to the control panel (closer than 2 meters is not permitted),
- To re-enroll a device, first disconnect its battery. Then wait about 10 seconds or, to save time, press and release its tamper switch to quickly discharge any remaining energy.
- A **sub-control panel** can be **enrolled** to a **master control panel** by keying in the sequence **299** on the keypad of the sub control panel which must be in **Service mode**. (see 12.10),
- If you intend to use final-door detectors in the system, they must be enrolled to addresses 01 to 05 or 46 to 50 (see 12.23).

11.3. Testing enrolled devices

1. The control panel must have its antenna connected and be in Service mode. If not in Service mode, then key in *0 service code (factory-default 8080). To enter Service mode the control panel must be initially unset (disarmed).
2. **Trigger the device** to be tested (if it is a detector close its cover first and then wait until it is ready for testing).
3. The keypad will beep and display a description of the signal received from the device under test (the keypad cover should be flipped open). We recommend technicians to carry the wireless keypad around while testing to ease the process.

Notes:

- Motion detectors JA-80P and JA-85P can be tested for a maximum of 15 minutes after closing their covers. After this period the detector will ignore frequent movements (see detector manuals for details).
- Devices can also be tested in maintenance mode – see 13.4.

11.4. Measuring signal strength

1. The control panel must have its antenna connected and be in Service Mode. If it is not, then enter *0 service code (factory default: 8080). The control panel must be unset (disarmed) to enter Service Mode.
2. Key in **298**, and the lowest enrolled address will be displayed.
3. **Trigger the device** enrolled to the displayed address. The keypad display will show the received signal strength on a scale of 1/4 to 4/4. Keep the keypad cover flipped open while measuring signals.
4. Other addresses for devices can be selected using the arrow keys to measure their signals too.
5. Exit signal measuring by pressing the # key.

Notes:

- Motion detectors JA-80P and JA-85P can be tested for a maximum of 15 minutes after closing their covers. After this period the detector will ignore frequent movements (see detector manuals for details).
- Measuring the signals from a JA-80L internal siren can be activated by pressing its button. A JA-80A outdoor siren can be activated for signal strength measurement by opening its cover thereby triggering its cover tamper switch.

- Each installed device should have a minimum signal strength of 2/4. If the signal is too weak, the device should be relocated or a higher control panel sensitivity can be selected. (see 12.36) Alternatively the control panel can be equipped with an external antenna (see 10).
- This measurement shows the quality of the signal received from the device at the control panel.
- The wireless keypad can be carried during installation or testing by disabling its tamper contact via the jumper near the tamper contact – do not forget to re-enable the tamper before finishing the installation – Note: the keypad usually has a slightly shorter working range than the detectors. Therefore, if carried to more-distant detectors the triggering of the detectors might not be shown.
- The most convenient way of measurement is via a computer running ComLink SW.

11.5. Erasing enrolled devices

1. The control panel must be in Service Mode. If it is not, then enter *0 service code (factory default: 8080). The control panel must be unset (disarmed) to enter Service Mode.
2. Key in “1” to enter enrollment mode and using the arrow keys select the desired address of the device you wish to erase.
3. **Press and hold** the “2” key until a **beep** is heard and the **A indicator** turns off.
4. After all the desired devices have been erased, press #.

Notes:

- To erase all wireless devices, press and hold the “4” key in enrollment mode.
- If a wireless keypad is erased, it will stop communicating with the control panel and must be re-enrolled before being used again. (see 7.1).

11.6. Enrolling the control panel to UC and AC modules

If you wish to use UC and AC modules to output PGX and PGY signals, you must enroll the control panel to these modules as follows:

1. The control panel must be in Service Mode. If it is not, then enter *0 service code (factory default: 8080).
2. On the UC or AC module, enter the desired enrollment mode (see the manual of the particular module)
3. Key in **299** on the control panel keypad and check that all LEDs on the module flash a few times to confirm successful enrollment.

Notes:

- Because the UC and AC modules have rather short enrollment-period timeouts, we recommend locating the module close to the control panel during enrollment. Alternatively you could carry the wireless keypad close to the module to perform enrollment.
- The control panel can be enrolled to the desired number of UC/AC modules to control multiple PG outputs in an installation.
- Each UC and AC module has 2 relays, X and Y which have to go through enrollment separately. The X relay reacts to PGX signals from an enrolled control panel and the Y relay reacts to PGY signals from an enrolled control panel. The control panel's PGX signal can be enrolled to the X relay and the control panel's PGY signal can be enrolled to the Y relay. Therefore, the enrollment procedure has to be done twice if both relays are to be controlled by the control panel's PG signals.
- Only one control panel can be enrolled to a UC or AC receiver because a control panel repeats its PG signals every 9

minutes so it is impossible to combine multiple control panels in one UC or AC receiver.

12. Control panel programming

The most convenient way to program the system is to use a PC running Comlink software. The system can however also be programmed by keying in the sequences in section 12.1.

- The system should be in Service mode (if not, enter the following with the system unset: “*0 Service code” – the factory default is 8080)
- Enter the appropriate programming sequences – see the following description (an unfinished sequence can be escaped from by pressing the # key),
- **To exit Service Mode** press the # key.

12.1. Control panel programming sequences

Function	Sequence	Options	Factory default	Notes
Entering enrollment mode One wireless device (detector, keypad, key fob, siren or sub control panel) can be enrolled to each address from 01 to 50 . The system offers vacant addresses one by one, if all addresses are occupied no devices can be enrolled. A device enrolled to address 01 or 02 disables the corresponding hard-wired input 01 or 02. In addition to enrollment mode, devices can also be enrolled by keying in their production codes (see 12.42).	1	Keys: up/down arrows = address scrolling holding 2 = erases the displayed address holding 4 = erases all addresses # = exiting enrollment mode	nothing	<ul style="list-style-type: none"> • devices enroll by connecting their power (battery), keyfobs also by pressing & holding a pair of their buttons • an occupied address is indicated by the A indicator being lit • enrolling a device to a new address will move it there
Exit delay time	20x	x = 1 to 9 (x10 s = 10 to 90 s)	30s	if a final door detector is used, then x is multiplied by 30s instead (i.e. from 30 to 270s)
Entrance delay time	21x	x = 1 to 9 (x 5 s = 5 to 45 s)	20s	
Alarm duration time	22x	x = 1 to 8 (min.), 9=15min	4 min.	0=10s (for testing)
PGX function	23x	x in an unsplit system: 0 - whole system set (ABC) = PG on 1 - any system part set = PG on 2 - AB set (not C) = PG on 3 - Fire alarm = PG on 4 - Panic alarm = PG on 5 - Any alarm = PG on 6 - AC dropout = PG on 7 - PG on/off (by *80 /*81 for PGX and *90/*91 for PGY) 8 - Single 2 s pulse (keys *8=X, *9=Y)	7 on/off (*80/*81)	x in a split system 0 - alarm A = PG on 1 - alarm B = PG on 2 - entrance delay A = PG on 3 - entrance delay B = PG on 4 - A set = X on, B set = Y on 5 - A panic = X on, B panic = Y on 6 - Fire = X on, AC dropout = Y on. 7 - PG on/off (by *80 /*81 for PGX and *90/*91 for PGY) 8 - Single 2 s pulse (keys *8=X, *9=Y)
PGY function	24x		1 any system part set	
Enablement of telephone number changes in maintenance mode	25x	251 = YES 250 = NO	NO	see communicator
Radio interference indication	26x	261 = YES 260 = NO	NO	30s or longer
Radio communication supervision	27x	271 = YES 270 = NO	NO	
RESET enabled	28x	281 = YES 280 = NO	YES	
Master control panel enrollment to a sub control panel for setting (arming) control	290	The sequence triggers enrollment.	(Un)setting the master control panel will (un)set the sub control p. The sub c. panel must be in enrollment mode.	
Master code reset	291	Returns master code to 1234	It has no effect on other codes and it is recorded in the control panel memory	
Measuring signal strength	298	Activates measurement	arrow keys scroll addresses, # halts measurement.	
Enrolling the control panel to UC, AC or a sub control panel	299	The sequence triggers enrollment.	see 12.10	
Setting (arming) without an access code	30x	301 = YES 300 = NO	YES	by keying: A, B, ABC, *1, *2, *3, *4
Triggered detector indication by text on the keypad display	31x	311 = YES 310 = NO	YES	allows the display of open windows & doors, to view details press ?
Confirmation of intruder alarms In this mode, the triggering of an intruder detector in a set (armed) section will only be recorded to the memory as an unconfirmed alarm and if then followed by the activation of any	32x	321 = YES 320 = NO	NO	An alarm can be confirmed by any other intruder detector in any section which

other intruder detector within 40 minutes, an alarm will be triggered. If the first triggered detector has a DEL reaction and it is not confirmed by any other detector, it will not trigger an alarm after the entrance delay has expired.					is set (armed).
Exit delay beeps	33x	331 = YES 330 = NO	YES		The last 5 s faster
Exit delay beeps while partially arming	34x	341 = YES 340 = NO	NO		The last 5 s faster
Entrance delay beeps	35x	351 = YES 350 = NO	YES		
Setting (arming) confirmation by wired-siren chirp	36x	361 = YES 360 = NO	NO		IW terminal only
Siren always sounds during audible alarms	37x	371 = YES 370 = NO	YES		NO = siren only sounds if the system is completely set (armed)
Wireless-siren alarms enabled (IW & EW)	38x	381 = YES 380 = NO	YES		
Auto-bypass user approval via the * key If a detector is active during setting (arming), the system will automatically bypass it (them), immediately (390), or after keying in * (391)	39x	391 = YES 390 = NO	NO		to confirm auto-bypass while exiting Service mode press # twice
Final-door detectors If this function is used, then Exit & Entrance delay settings are multiplied by 30s. A triggered final-door detector extends the exit delay, de-triggering of the last final-door detector ends the exit delay.	65x	0=none, 1=detectors 01 to 05, 2=detectors 46 to 50	x = 0		If multiple F. door detectors are used, then triggered state=any of them, non triggered state=all of them
Partial setting (arming) or system splitting	66x	0 = unsplit system 1 = partial setting (A, AB, ABC) 2 = split system A, B & common section C (set if A & B are set)	unsplit		
Automatic Summer Time (Daylight Saving Time)	680x	6801 = YES 6800 = NO	NO		Changes internal clock + 1h on Apr.1 & -1h on Nov.1
Tamper-signal differential indication - Tamper alarm in response to an increase in the number of triggered tamper sensors	681x	6811 = ignore permanently triggered tamper sensors, i.e. only react to an increase in the number of triggered tamper sensors 6810 = react with a tamper alarm to all triggered tamper sensors	X = 0		Suppresses the indication of permanently triggered tamper sensors
Operating the PG outputs using *8 and *9	682x	6821 = YES 6820 = NO	YES		if yes then arrow keys can also operate PGX
Permanent alarm status display for a set system	683x	6831 = YES 6830 = NO	NO		suppresses the 3min. display timeout
Tamper alarm if unset (disarmed)	684x	6841 = YES 6840 = NO	NO		
Recording PG output activation to memory	685x	6851 = YES 6850 = NO	YES		
Engineer reset	668x	6851 = YES 6850 = NO	NO		
Annual check requirement display If enabled then 12 months after exiting Service Mode an annual technical check request is displayed on the keypad unit (mobile phone & ARC notification optional)	690x	6901 = YES 6900 = NO	NO		
Only single alarm indication If enabled then another intruder alarm can not be triggered during an intruder alarm currently in progress.	691x	6911 = YES 6910 = NO	NO		
Setting (arming) by service code	692x	6921 = YES 6920 = NO	NO		only with the master code holder's approval
Audible panic alarm	693x	6931 = YES 6930 = NO	NO		
Higher control-panel receiver-sensitivity Extends the communication range if there is no RF interference	694x	6940 = normal 6941 = higher	normal		
Access by Code plus Card If enabled and there is a code and card assigned to the same user, then both of them must be presented for setting (arming) control (in any order).	695x	6951 = Code+Card 6950 = Code or Card	code or card		
Audible 24h intruder alarm	696x	6961 = YES 6960 = NO	YES		
Service mode only with Service + Master code	697x	6971 = YES 6970 = NO	NO		

<p>Device reactions and section assignment (detectors, key fobs, control panel and keypad inputs)</p> <ul style="list-style-type: none"> • A detector's natural reaction can be INS, DEL or Fire (selectable in the detector) • The natural reaction of Control panel & Keypad wired inputs is DEL <p>Keyfob natural reactions: (or) = SET (arm) , (or) = UNSET (disarm) and both simultaneously = Panic. If a reaction from 2 to 8 is selected (see opposite), only the key (or) and double buttons + (+) will have it. The () button has no effect (can still be used for controlling UC/AC receivers).</p> <ul style="list-style-type: none"> • Assignment to sections will only have an effect on partial arming or if the system is split (except PG output control) • For partial arming, a pair of keyfob buttons assigned to section: <p>A has the effect: (or)=SET A, (or)=SET AB</p> <p>B has the effect: (or)=SET A, (or)=SET AB</p> <p>C has the effect: (or)=SET ABC, (or)=UNSET ABC</p> <ul style="list-style-type: none"> • In a split system, a keyfob button pair assigned to section: A=SET/UNSET A, B =SET/UNSET B, C =SET/UNSET ABC 	<p>61 nn r s</p>	<p>nn = address 01 to 50 r = reaction 0 disabled (incl. tamper sensor) 1 Natural – this means: for detectors=selected by DIP switch in the detector, for wired inputs=DELAy, for Codes (cards)=SET/UNSET 2 Panic 3 Fire 4 24 hours 5 Next DELay 6 INSTant 7 SET (arm) 8 PG control (s: 1=PGX, 2=PGY,3=PGX+PGY) 9 SET/UNSET (toggle)</p> <p>s = section 1=A, 2=B, 3=C - has to be entered even if the system is not split and setting (arming)has no meaning. In a split system, a code (card) assigned to C will SET/UNSET all ABC sections</p>	<p>all Natural in C</p>	
<p>Code (card) reactions and section assignment</p> <ul style="list-style-type: none"> • A code (card) may have the same kind of reaction as devices 	<p>62 nn r s</p>			
<p>Enrollment by keying in production codes</p>	<p>60 nn xxxxxxxx</p>	<p>nn = address 01 to 50, xxxxxxxx = last 8 digits of the production code (below the bar code on the device)</p>		
<p>Automatic Daily Setting/Unsetting schedule (arming/disarming)</p>	<p>64nahhmm</p>	<p>n – action sequence index (0 to 9) a – action: 0=no action 1=SET ABC 2=UNSET ABC 3=SET A 4=SET B (if unsplit then AB) 5=UNSET A (if unsplit then ABC) 6=UNSET B (if unsplit then ABC) hh - hours, mm - minutes</p>	<p>No action</p>	<p>The scheduled actions will happen every day</p>
<p>Changing the service code</p>	<p>5 NC NC</p>	<p>NC = new code (4 digits)</p>	<p>8080</p>	<p>enter NC twice</p>
<p>Go to maintenance mode</p>	<p>292</p>	<p>switches to maintenance mode</p>	<p>-</p>	
<p>Setting the internal clock</p>	<p>4 hh mm DD MM YY</p>		<p>00:00 1.1.00</p>	
<p>Editing keypad text Text for device names, code names and PG output names are stored in each individual keypad.</p>	<p>Press and hold the ? key to enter text editing (the first character of the first address name will start flashing). Then use keys: ▲ and ▼ to select some text (or an address) 1 & 7 character selection (A,B,C,D...8,9,0) 4 & 5 cursor (to the left & right) 2 to erase a character # = exit editing and save changes</p>		<p>Device</p>	<p>Only capital letters can be entered this way. If there are multiple keypads, each must be edited individually this way or all of them can be easily programmed via Comlink software</p>

12.2. Exit delay time

An exit delay time occurs while setting (arming) the system. During this time period delayed or next-delayed detectors can be triggered without an alarm occurring. To program the delay time, enter:

20x

where **x** is a number from 1 to 9 determining the duration in steps of tens of seconds (1=10 s, 2=20 s,...)

If there is a final-door detector in the system then the exit delay is multiplied by 30 s instead (1=30 s, 2=60 s,...)

Example: To program a 20 seconds exit delay, use the sequence 202 (if there is a final door detector, a 60 seconds delay will result) .

Factory default setting: x = 3

12.3. Entrance delay time

The entrance delay time is provided to unset (disarm) the system after a first delayed detector has been triggered. To program this time, enter:

21x

where **x** is a number from 1 to 9 determining the delay in multiples of 5 seconds (1=5 s, 2=10 s,...)

If the entrance delay is triggered by a final-door detector, then parameter **x** is multiplied by 30 s instead. (1=30 s, 2=60 s,...) – in this case it means that the entrance delay would be six times longer than if it had been triggered by an ordinary detector.

Example: To program a 20 seconds entrance delay, enter the sequence 214 (if the delay has been activated by a final-door detector, a 120 seconds delay will result instead).

Factory default setting: x = 4

12.4. Alarm duration time

This parameter limits the duration of a triggered alarm. After the alarm state expires, the control panel will return to its previous state, i.e. as before the alarm occurred. The alarm state can also be terminated by an authorised user. To program the alarm duration enter:

22x

where **x** is a number from 0 to 9 determining the alarm duration: 0 = 10 s, 1 = 1 min., 2 = 2 min. up to 8 = 8 min., 9 = 15 min.

Note: There can be up to 5 different alarms in the system: intruder, tamper, fire, panic, and technical alarm.

Example: Alarm duration of 5 min. = sequence 225

Factory default setting: 4 minutes

12.5. PGX and PGY functions

The functions of PGX and PGY can be programmed by entering sequences:

2 3 x for PGX

2 4 x for PGY

where **x** determines the PG function or the event which triggers a change of PG state:

x	Unsplit system	Split system
0	Completely (ABC) set = PG on	Alarm A = PG on
1	Anything set = PG on	Alarm B = PG on
2	AB set (not ABC) = PG on	Entrance delay A = PG on
3	Fire alarm = PG on	Entrance delay B = PG on
4	Panic = PG on	A set = PGX on, B set = PGY on
5	Any alarm = PG on	Panic A = PGX on Panic B = PGY on
6	AC dropout = PG on	Fire = PGX on, dropout = PGY on
7*	ON/OFF	
8*	2 seconds pulse	

* The ON/OFF and 2 second pulse functions can be controlled from the keypad by keying in * 8, *9 or using the arrow keys ▲ ▼ (see 12.27) or they can be operated by a code or card. These PG output functions can also be controlled by signals from keyfobs or detectors (see 12.41).

Notes:

- The PGX and PGY outputs are not only provided as control panel terminals, but the signals are also wirelessly transmitted for UC and AC modules.
- The status of PGX and PGY outputs can be displayed by pressing the "?" key. The names of the outputs can be edited – see 12.47.

Example (for unsplit systems): Assigning an ON/OFF function to the PGX output = sequence 237. Assigning a panic function to the PGY output = sequence 244.

Factory default setting: PgX= ON/OFF, PgY= anything set

12.6. Changing telephone numbers in maintenance mode

If the control panel is equipped with a JA-80Y, JA-80V or JA-80X communicator, then this sequence enables the holder of the master code (system administrator) to program telephone numbers for alarm reporting in maintenance mode. Programming telephone numbers is the same as in Service mode (see communicator manual):

2 5 1 programming enabled

2 5 0 programming disabled

Factory default setting: programming disabled.

12.7. Radio interference indication

The control panel is capable of detecting and indicating radio communication jamming. If this function is enabled, any radio jamming longer than 30 s will trigger fault indication.

2 6 1 enabled

2 6 0 disabled

Factory default setting: disabled.

Note: In some places the system can be permanently or occasionally affected by radio interference, e.g. by nearby radar stations, TV transmitters etc. In most cases the system can tolerate such effects, but with this anti-jamming function disabled.

12.8. Radio communications supervision

If enabled, the control panel can routinely check wireless connections to its devices. If communication with a particular device is lost, the control panel can communicate a fault indication to the user:

2 7 1 indication enabled

2 7 0 indication disabled

Notes:

- In the Oasis system, communication is checked every 9 mins.
- In detectors used for car protection, (JA-85P, JA-85B) it is possible to disable radio communication supervision. It allows car detectors to be excluded from supervision to avoid alarm triggering when driving the car away from the system.
- Random dropouts in communication can occur in some installations near e.g. airports or TV towers. The system is still reliable in such situations as high-priority transmissions are repeated often. We recommend disabling communications supervision in cases like this.

Factory default setting: supervision disabled.

12.9. RESET enabled

If resetting is enabled, it is possible to return the control panel to its original factory-default settings via the reset link on the main board. (see section 9.)

2 8 1 RESET enabled

2 8 0 RESET disabled

Warning: If resetting is disabled and the service code has been forgotten, it would no longer be possible to enter Service mode. If this happens, send the control panel back to the manufacturer.

Factory default setting: RESET enabled.

12.10. Enrollment to a sub control panel for setting (arming) control

If the control panel has another Oasis control panel enrolled as a sub-system, then the sub-system reports all alarms, tampering and faults to the master control panel. The master control panel reacts to particular signals accordingly, and displays the sub control panel's address as the source.

After sub control panel enrollment to the master control panel, these two panels are independent concerning setting control. Each panel can be operated by its own keypads or keyfobs. If there is an alarm or fault in the sub control panel, it is also indicated on the master control panel. In this configuration it is impossible to control the sub control panel from the master control panel..

If it is desired to control a sub control panel from a master control panel (i.e. setting/unsetting), it is possible to enroll a JA-80 Oasis master control panel to a sub control panel as a remote control as follows:

- First enroll the sub control panel to the desired address in the master control panel by entering 299 on the sub control panel's keypad in Service Mode - see 11.2.7 for full details.
- Switch the master control panel to Service Mode.

3. In the sub control panel, enter enrollment mode by keying in "1" in Service Mode and select the desired address.
4. In the master control panel enter 290. This way the control panel will enroll to the sub control panel to the desired address as a remote control.
5. Switch both control panels to maintenance mode and check that all-section setting of the master control panel also sets the sub control panel and unsetting the master control panel unsets the sub control panel too. Expect approximately 2 seconds of delay between control panels.

Notes for operating the sub control panel:

- The sub control panel can still be operated independently via its keyfob or keypad e.g. it can be set while the master control panel is unset. If the master control panel changes its status later on, it will then control the sub control panel to achieve synchronisation.
- To disable the master control panel's ability to control the sub control panel, enter the sub control panel's enrollment mode, select the address where the master control panel is enrolled and erase the master control panel from this address by pressing and holding key 2.

12.11. Master code reset

If the master code has been forgotten or a card lost, it is possible to use the following sequence to reset the master code to the factory-default 1234:

291

Note: Resetting the master code has no effect on other codes and cards. Resets are recorded in the control panel memory and sent to the ARC if used (Alarm Receiving Centre, previously called a central monitoring station).

12.12. Control panel enrollment to UC or AC modules or to a sub control panel

Keying in **299** sends an enrollment signal to enroll the control panel to UC-82 or AC-82 receiving modules (see 11.6). This sequence can also be used to enroll a sub control panel to a master control panel (see 12.10).

12.13. Setting (Arming) without an access code

"Hot" setting keys (short-cut keys for setting) A, B, ABC or entering "* number" can be enabled for use without a valid access code or card. If disabled, then hot key use or entering "* number" has to be followed by a valid access code or card to have any effect:

Function/sequence	301	300
All-section setting	ABC key	Code/card
Setting of A	A key	A key, code/card
Setting of AB (or B)	B key	B key, code/card
Event memory recall	*4	*4 code/card

- If you remotely operate the system by mobile phone, you can press *1 for the ABC key, *2 for key A, and *3 for key B.
- Controlling the PG outputs by keying in *8 or *9 or pressing ▲ and ▼ is unaffected by these settings. These keys can however be disabled by a special sequence (see 12.27).

Factory default setting: Setting (arming) without an access code enabled.

12.14. Triggered-detector indication

Pressing the ? key checks if any detectors are permanently triggered, e.g. if any doors or windows are open. The following sequence enables the display of text concerning active detectors.

- 3 1 1** indication enabled
- 3 1 0** indication disabled

Factory default setting: indication enabled

12.15. Confirmation of intruder alarms

To reduce the risk of false alarms and to comply with British standard BSI DD243, the control panel allows alarm confirmation logic to be enabled as follows:

- 3 2 1** confirmation logic **enabled**
- 3 2 0** confirmation logic **disabled**

Confirmation logic:

- If the system is set (armed) and any intruder detector gets triggered, i.e. a detector with an instant, delayed, or next-delayed reaction, an alarm will not be caused but the control panel will record a so-called unconfirmed alarm.
- If any other intruder detector is triggered in a set section within 40 minutes of the above event, an intruder alarm will be triggered. If no other detector is triggered during this period, the control panel will stop waiting for confirmation.
- The alarm must be confirmed by another detector than the first one, and if the second one is a motion detector its detection area must not cover the same area as the first detector to be triggered. This must be ensured by the proper location of detectors.
- An unconfirmed alarm is recorded in control panel memory but can also be sent to the ARC, or to the user by SMS report.
- If the first triggered detector has a delayed reaction, it will start a so-called unconfirmed entrance delay. This delay is indicated the same way as an ordinary entrance delay, but if no other delayed detector is triggered during this delay, there will be no alarm if the unconfirmed entrance delay is exceeded, with another unconfirmed alarm being recorded in the control panel memory. If there is any other delayed or next-delayed detector triggered during the entrance delay period, it will confirm the entrance delay, and if this delay is exceeded (due to no unsetting being done) it will trigger an intruder alarm at the end of the delay.
- If the unconfirmed entrance delay is confirmed by an instant detector it will trigger an internal warning alarm immediately (e.g. an internal siren) and if the entrance delay times out then an external alarm will be triggered.
- An unconfirmed alarm can be confirmed by any other intruder detectors in the system as long as the detectors are assigned to a set (armed) section.
- The confirmation of intruder alarms has no effect on fire, panic, 24-hour, tamper, or technical alarms. These alarms are triggered immediately without confirmation.

Note: When the first detector is triggered it begins a process which waits 40 minutes for any possible confirmation of the alarm (unconfirmed alarm status) during which the system works exactly the same way as if the confirmation function had not been enabled.

Warning: If intruder alarm confirmation is enabled, it is necessary to install enough detectors in the building to detect an intruder even if he/she is only moving in one particular place.

Factory default setting: confirmation disabled

12.16. Exit delay beeps

The exit delay can be indicated by beeps from the keypad and internal siren. The beeps get faster in the last 5 seconds.

- 3 3 1** Beeps **enabled**
- 3 3 0** Beeps **disabled**

Factory default setting: Beeps enabled.

12.17. Exit delay beeps while partially setting (arming)

The exit delay caused by partial setting, e.g. using the A or B key, can also be indicated by keypad beeps and internal-siren beeps. The beeps get faster in the last 5 seconds.

- 3 4 1 Beeps **enabled**
- 3 4 0 Beeps **disabled**

Factory default setting: Beeps disabled.

12.18. Entrance delay beeps

The entrance delay can be indicated by keypad beeps and internal-siren beeps:

- 3 5 1 Beeps **enabled**
- 3 5 0 Beeps **disabled**

Factory default setting: Beeps enabled

12.19. Setting (arming) confirmation by wired-siren chirp

A hard-wired siren connected to the IW terminal of the control panel can audibly indicate setting by one beep, unsetting by two beeps and unsetting after an alarm by three beeps. Four beeps mean an invalid attempt at setting the system has occurred.

- 3 6 1 Chirps **enabled**
- 3 6 0 Chirps **disabled**

Note: In JA-80L wireless sirens, this function can be individually enabled for each siren. (see the siren manual).

Factory default setting: Hard-wired siren chirps **disabled**

12.20. Sirens always sound during audible alarms

Using this sequence it is possible to disable internal and external sirens (IW and EW) if any part of the system is unset (partial setting), i.e. when someone is home.

- 3 7 1 Sirens always sound during audible alarms
- 3 7 0 Sirens only sound during audible alarms when all sections are set, i.e. no one is home

Factory default setting: Sirens always sound during audible alarms.

12.21. Wireless siren alarm enabled (IW and EW)

This setting is for enabling and disabling wireless sirens in the system:

- 3 8 1 wireless sirens **enabled**
- 3 8 0 wireless sirens **disabled**

Note: This setting has no effect on wired output terminals.

Factory default setting: wireless sirens **enabled**

12.22. Auto-bypass user approval via the * key

The system has a built-in auto-bypass function so that if any number of detectors are being triggered during setting (arming) then they will be bypassed and ignored automatically.

If auto-bypass approval by the user is disabled, then during setting (arming) the system notes which detectors are currently triggered and automatically bypasses them without consulting the user.

If however, auto-bypass user approval is enabled, then during setting (arming), the system notes which detectors are currently triggered and displays informative text on the keypad and only bypasses them if the user approves the bypassing by keying in a * within 6 seconds of being notified.

- 3 9 1 Approval is requested from the user
- 3 9 0 Bypassing occurs automatically without user approval

Notes regarding setting the system with (a) triggered detector(s):

- Details on currently triggered detectors can be viewed by pressing the ? key (e.g. open doors or windows).
- If a wireless keyfob is used to set the system and auto-bypass user approval is enabled, the system will set without bypass approval, i.e. setting by keyfob does not trigger an approval request.
- The automatic bypass of a detector will end after the detector has been de-triggered (for example if a door is closed)
- If auto-bypass user approval is enabled and Service mode is being exited while a detector is being triggered, the installer will be notified about the bypass. The installer can then approve the bypass by pressing # twice.
- To comply with the EN-50131-1 standard 391 should be set.

Factory default setting: Bypassing occurs automatically without user approval

12.23. Final-door detectors

In this mode, up to 5 detectors can be defined as final-door detectors and assigned to addresses 01 to 05 or 46 to 50 in order to make leaving a building much easier, especially via a garage:

65x

- where x: 0 = none,
1 = detectors on addresses 01 to 05,
2 = detectors on addresses 46 to 50

Description of final-door detector mode:

- If a final-door detector is used in the system then the value of x for exit delay programming is multiplied by 30 s (see 12.1) thereby extending the delay, and if an entrance delay is triggered by a final-door detector then the value of x for the entrance delay is also multiplied by a larger value of 30 s.
- A final-door detector should be programmed to have a natural reaction.
- Door/window detectors, hard-wired control panel inputs or hard-wired inputs in the wireless keypad unit can be used as final-door detectors.
- If a final-door detector is used for a garage door, no instant detectors should be inside the garage. Next-delay detectors would however be acceptable.

Setting (arming) the system with a final-door detector

- After entering a request to set the system, an exit delay of between 30 to 270 seconds will begin and be indicated.
- If a final-door detector is triggered during the exit delay, the exit delay will be extended by the time in which the detector is still triggered. So, if for example, the door is left continuously open, the exit delay will never end.
- If a final-door detector is de-triggered, the system will wait five more seconds during which beeping gets faster, and if the door is not opened again during this short period, the exit delay will terminate and the system will be set immediately.
- The duration of the exit delay therefore depends on the time the final door stays open. For instance, in winter if the driveway in front of a garage needs to be cleared of snow there will be plenty of time to do it, and in summer when garages can be exited easily and therefore quickly, the exit delay can be rather shorter. The exit delay only depends on the length of time the garage door is left open.
- If no final-door detectors are triggered during the exit delay, the system will provide an exit delay and then set.
- If the final door detector stays continuously triggered, an endless exit delay will result with the system never being set. This means all delayed and next-delayed detectors will not be set (armed).
- If there are multiple final-door detectors in the system, the exit delay is extended if any of them is triggered and ends after all final-door detectors have been de-triggered.

Unsetting (disarming) the system with a final door detector

- If a final-door detector gets triggered in a set (armed) system, an entrance delay will begin with a duration of between 30 and 270 seconds.
- If a normal delayed detector gets triggered while the user enters a building, the system starts an ordinary entrance delay of between 5 and 45 seconds.
- If a final-door detector is triggered first, a longer entrance delay will begin. If during this delay an ordinary delayed detector is then triggered, the remaining entrance delay will then be shortened to the delay associated with detectors of this kind.

Note: Only use status-reporting detectors such as the JA-80M or JA-82M, or the hard-wired inputs of wireless keypads, or the hard-wired inputs of a control panel as final-door detectors. This mode is unsuitable for pulse detectors such as JA-80P motion detectors, or the hard-wired inputs of JA-80E hard-wired keypads which also have a pulse reaction.

Factory default setting: No final-door detectors in the system.

12.24. Partial setting (arming) or system splitting

The control panel can be configured in three ways as follows:

- the entire system sets and unsets together or,
- the system partially sets and unsets to protect only certain parts of a house during the day, while people are still present in the unset parts or,
- the system can be split into two independently set/unset sections for two separate users and also with a common section if desired.

Program as follows to configure the system as desired:





66x

where **x=0** = **unsplit system** (setting/unsetting as an entire system)

x=1 = **partial setting** (for setting sections A, AB, or ABC)

x=2 = **split system** (sections A and B can be set/unset independently by separate users, with section C only being automatically set when both A and B are manually set)

Notes:

- **For an unsplit system**, all intruder detectors are set/unset immediately after the user sets/unsets the system. Assigning wireless devices, access codes and keyfobs to various sections of the system has no effect in this mode.
- **Partial setting** is especially suitable for homes and apartments where the user wishes to protect different parts of the premises during the day. Detectors can be assigned to three sections, A, B and C. Using setting (arming) key A on the system keypad, you can set section A, e.g. setting the garage area in the afternoon. Using setting key B you can set sections A and B simultaneously e.g. in the evening before going to sleep to protect the garage (section A) and the ground floor of the house (section B). The ABC total-setting button is used when leaving the home to set all sections, A,B and C. If you then use a valid access code or card for unsetting (disarming), all sections will be unset. The assignment of codes or cards to sections has no effect in this mode.
- A keyfob can also be used for partial setting control. Buttons  and  can be programmed to set and unset the entire system, and buttons  +  can be programmed for setting (arming) sections A and AB respectively to partially set the system. (see 12.40 for details on partial setting by keyfob).
- **Split system mode** is especially suitable where two families (A and B) live in a single house or two companies (A and B) share one building. The system behaves as two independent systems, one being section A and the other, section B. There is also a common section C which is only set if section A and section B are set at the same time, and is commonly used for shared entrances, doors etc. Detectors can be assigned to sections A, B or C. Access codes and cards can be assigned to operate either section A or B (not both), or alternatively to section C to access the entire building. The same is true for keyfob access.

- *Partial setting only has an effect on intruder detectors, i.e. detectors with instant, delayed or next-delayed reactions. Detectors with fire, tamper, panic and 24-hour reactions are always able to trigger their kind of alarm immediately, whether their section is set (armed) or not.*

Factory default setting: Unsplit system.

12.25. Automatic summer time (daylight saving time)

If enabled, this feature automatically offsets the system time to that of summer time, or daylight saving time as it is also known,:

6801 automatic summer time enabled

6800 automatic summer time disabled

Note: If automatic summer time is enabled, the control panel's internal clock is automatically offset by +1 hour on March 31st at midnight. The offset is then removed on October 31st at midnight to return to winter time.

Factory default setting: automatic summer time disabled

12.26. Tamper alarm in response to an increase in the number of triggered tamper sensors

This feature allows permanently triggered tamper sensors to be ignored:

6811 ignore permanently triggered tamper sensors, i.e. only react to an increase in the number of triggered tamper sensors.

6810 react with a tamper alarm to all triggered tamper sensors

Note: Ignoring permanently triggered tamper sensors is useful for example when carrying a detached wireless keypad around with you during installation as this avoids unnecessary tamper indication.

Factory default setting: react with a tamper alarm to all triggered tamper sensors

12.27. Operating the PG outputs using *8 and *9

Using this feature the PGX and PGY outputs can be controlled from the keypad by pressing the *8 and *9 keys (or keys ▲ and ▼).

6821 control enabled

6820 control disabled

Notes:

- The PG outputs can only be operated from the keypad if they have their ON/OFF or pulse functions enabled.
- In addition to controlling the PG outputs using keys *8 and *9, PG outputs can also be controlled by access codes, access cards, keyfobs and detector signals (see 12.40 and 12.41 for details).
- If a PG output should only be operated by a valid access code or card, then control by *8 and *9 should be disabled and the codes and cards should be programmed to control the PG outputs instead (see 12.41).

Factory default setting: control enabled

12.28. Permanent alarm status display for a set system

The below sequence enables the permanent display of alarm status on the keypad unit, even if the system is set.

6831 permanent status display enabled

6830 display time a maximum of 3 minutes if any section is set (armed)

Notes:

- European legislation requires status displaying to be suppressed within three minutes of setting (arming) the system, no matter how much or little of the system is set. This feature can be used to ignore this requirement if appropriate.
- The wireless keypad can continuously display the status if powered by an external power supply. If powered by internal batteries the keypad will turn off its display after 20 seconds of not being used (in Service Mode the display turns off after 15 minutes of no use by the installer).

Factory default setting: only 3 minutes of display time

12.29. Tamper alarm if unset

According to EU legislation an unset (disarmed) system should not audibly sound a tamper alarm if tampering occurs. If the audible indication of tamper alarms is required while the system is unset (disarmed) then this can be enabled by the following sequence:

- 6841** audible tamper alarm even for an unset system
- 6840** silent tamper alarm for an unset system

Notes:

- Even if tamper alarms are silent, they are still recorded in the control panel memory and reported to the end user by SMS, and also to the ARC if used.
- If the sequence 370 has been programmed, then tamper alarms will be silent if the system is unset or partially set.

Factory default setting: silent tamper alarms for an unset system

12.30. Engineer reset

This is a special function requested by the DD243 standard. It can only be used when the alarm system is connected to an alarm-receiving center. When a confirmed alarm is activated the control panel is completely blocked – it cannot be operated by any user, master or service code until an engineering reset is performed by an ARC code.

- 6861** Engineer reset enabled
- 6860** Engineer reset disabled

Factory default setting: Engineer reset **disabled**

Notes:

- To enable the confirmation of intruder alarms (requires two detectors to be triggered in different zones within a definite period) – use sequence 3 2 1
- Reporting to ARCs must be locked by a digital code.
- The keypad shows the text “Eng. reset req’d” and the system stays blocked until the ARC code is used via the communicator (see manual).
- The feature is supported when a JA-80Y version XA61008 or higher, or a JA-80V version XA64005 or higher is installed.

12.31. Recording PG output activation to memory

The activation of PGX and PGY outputs can be recorded in the control panel’s memory (for example if the outputs are used for access control). This can be enabled by the following sequence:

- 6851** enabled
- 6850** disabled

Factory default setting: recording enabled

12.32. Annual check notification

This sequence enables the user and installer to be notified of the necessary time for an annual technical check:

- 6900** notification **disabled**
- 6901** notification **enabled**

Notes:

- An annual technical inspection notification is displayed as text on the keypad display and can also be sent as an SMS to the end user and/or installer and/or as a report code to an ARC, if used.
- Annual technical inspection notification text disappears on entering Service Mode
- When this notification is enabled, exiting Service Mode will cause a notification to occur in the next year on the first day of the month in which it was set. (e.g. if you set the annual check notification on the 15th October 2007, the notification is displayed on the 1st October 2008.)
- When this notification is enabled, exiting Service Mode will cause a notification to occur every twelve months later (the same day and month).

- If you wish to receive a notification earlier than a year later, change the internal clock settings to the day and month you prefer before exiting Service Mode by entering 4hhmmDDMMYY, and then re-adjust the clock to the correct time in maintenance mode. By tricking the system this way, you can be notified on the desired date. (see 12.45, entering and exiting maintenance mode does not change the notification date).

Example: If the date is 10 January 2007 and you wish to receive a notification 6 months later on 10 July 2007, while still in Service Mode change the system clock to 10 July 2007, i.e. the day and month of the desired notification date. Then exit Service Mode and re-adjust the clock to the correct time in maintenance mode.

Factory default setting: Annual inspection notification disabled.

12.33. Only single alarm indication

If this function is enabled, then only one intruder alarm may be indicated at a time. Once an intruder alarm has been triggered and has still not ended, then no more alarms can be indicated no matter how many more times triggering occurs. After the alarm has ended, the system is then ready to indicate the next single intruder alarm.

This is to limit the number of SMS reports sent if hard-wired PIR detectors capable of being frequently triggered are installed in the system and the system is not unset (disarmed) properly when someone enters the building.

- 6 9 1 0** multiple simultaneous intruder alarms allowed
- 6 9 1 1** single intruder alarm allowed only

Note: Apart from this limitation in the number of simultaneous intruder alarms, the system also checks to see if any detector is triggering multiple alarms during the period in which the alarm is set. Any such undesirable detector is then **automatically bypassed** every time the system is set, if it has caused at least **four alarms in a row**.

Factory default setting: multiple simultaneous intruder alarms allowed

Note: A panic alarm can always be triggered with no limits (except when in service and maintenance modes).

12.34. Setting (arming) by service code

Using this sequence, the installer can be authorized to set and unset the system by means of a valid service code. This feature should only be enabled with the explicit approval of the master code holder (system administrator):

- 6 9 2 0** disabled
- 6 9 2 1** enabled

Factory default setting: disabled

12.35. Audible panic alarm

If enabled, panic alarms can be indicated by internal and external warning devices (sirens on IW and EW):

- 6 9 3 0** silent panic alarm
- 6 9 3 1** audible panic alarm

Note: If the sequence 370 is used, panic alarms are silent if any section of the system is unset.

Factory default setting: silent panic alarm

12.36. Higher control-panel receiver-sensitivity

If enabled, this feature can extend the communication range between the control panel and its wireless devices if there is no radio frequency interference in the premises.

- 6 9 4 0** standard control panel sensitivity
- 6 9 4 1** higher control panel sensitivity

Note: The sensitivity of the control panel receiver should only be increased if there is no RF interference as the radio range would only be reduced if interference was present.

Factory default setting: standard control panel sensitivity

12.37. Access by code plus card

This feature increases security against unauthorised setting/unsetting (arming/disarming):

- 6950** system access by code or card
- 6951** system only accessed by code and card if both are assigned to the same user position

Notes:

- The system has up to 50 user positions (01 to 50) each capable of having an access code and an access card assigned to it. If both a code and a card are assigned to a user then the above sequences (6950 and 6951) determine whether the user can use a code or a card or whether he must present both a card and a code to gain control over the system. If both a card and a code have to be presented, the order in which they are done is unimportant.
- If only a card or only a code is assigned to a user, then the above settings have no effect on users like this.

Factory default setting: system operated by code or card

12.38. Audible 24 hour intruder alarm

The 24-hour intruder alarm which can be triggered whether the system is set or not, and can also be silent or audible (IW and EW) according to the following sequences:

- 6 9 6 0** silent 24-hour intruder alarm
- 6 9 6 1** audible 24-hour intruder alarm

Note: If sequence 370 is programmed, the intruder alarm will be silent if any section in the system is unset.

Factory default setting: audible 24 hour intruder alarm

12.39. Service mode only with service code and master code

To prevent the installer from accessing Service Mode without a user's permission, this feature (if enabled) makes it compulsory for the master code (or any valid user code) to be entered directly after entering the service code to access Service mode. Service Mode can then be entered by keying in *0 service-code master-code(or user-code).

- 6 9 7 0** Only service code needed.
- 6 9 7 1** Service code and master code (or user code) needed.













Factory default setting: Only service code needed.

12.40. Device reactions and section assignment

The following sequence programs the characteristics of system devices :

- 61 nn r s**
 where: **nn** is the device address from 01 to 50 (01 and 02 can either be the hard-wired input terminals in the control panel or enrolled wireless devices)
r is the reaction index from 0 to 9 – see Table 2
s is the section 1 = A, 2 = B, 3 = C (only has an effect if partial setting or system splitting is used – except for PG output control)

Guidance on assignment to sections:







Assigning keyfobs with natural reactions to sections				
s	button	Unsplit system	Partial setting	Split system
1	 (or )	set	set A	set A
	 (or )	unset	set AB	unset A
2	 (or )	set	set A	set B
	 (or )	unset	set AB	unset B
3	 (or )	set	set ABC	set ABC
	 (or )	unset	unset ABC	unset ABC

- If partial setting is programmed then detectors can be assigned to sections: A (s=1), B (s=2) a C (s=3). The three possible setting (arming) options are as follows:

- A** (using the A key on the keypad, e.g. setting (arming) the garage in the afternoon),
- AB** (using the B key on the keypad, e.g. setting (arming) the garage and the ground floor during the night)
- ABC** (using the ABC key on the keypad, e.g. to set the entire system when leaving the house).





- In a split system, detectors can be assigned to sections: A (s=1), B (s=2) a C (s=3). Sections A and B can be set independently and section C is a common section which only sets when A and B are set.
- Partially setting and splitting a system only have an effect on intruder detectors with instant, delayed or next-delayed reactions. Detectors with fire, tamper, panic, and 24-hour reactions are continuously ready to trigger an alarm no matter which section they are assigned to or whether their section is set or not.
- If the selected reaction is **PG output control** then the s parameter defines which PG output is controlled: **s=1 PGX, s=2 PGY, s=3 PGX and PGY.**

Guidance on programming reactions:

- The reaction selected in a detector by its internal DIP switches is only obeyed by the control panel if the reaction programmed in the detector's address is a natural one (r=1).
- **Keyfobs** always enroll a pair of buttons (+) or (+). The natural reaction of such a pair of buttons is shown in the above table. If any other reaction is selected for a keyfob, this reaction will only apply to the first button of the pair, i.e.  or  (except for controlling the PG outputs).

Factory default setting: All addresses from 01 to 50 have a natural reaction (r=1) and are assigned to section C (s=3).

Table 2 Control panel reactions

r	Reaction	Notes
0	Disabled	For temporarily disabling codes or devices including tamper sensors
1	Natural	For detectors = instant, delayed or fire (selectable in detectors by DIP switch) For hard-wired inputs of the control panel or keypad = delayed Keyfobs  (or ) =set,  (or ) =unset, both buttons = panic Code = set/unset (see reaction r=9)
2	Panic	Triggers a panic alarm (audible or silent, see 12.35)
3	Fire	Triggers a fire alarm
4	24 hours	Triggers an intruder alarm even if the system is unset (audible or silent – see 12.38)
5	Next delay	Always provides an exit delay. An entrance delay is only provided if it is triggered shortly after a delayed detector.
6	Instant	If activated in a set (armed) section, it triggers an intruder alarm instantly
7	Set	Sets its own section of the system
8	PG output control	The value of the s parameter determines which PG output is controlled: s= 1= PGX, s=2=PGY or s=3=PGX & PGY. To use this function the PG output involved has to be programmed to the ON/OFF or pulse functions. If the reaction is triggered by: a code (card) – the PG output changes its state (ON,OFF,ON,OFF.....) or a pulsed switching event is generated after a valid code or card is used. If a code or card is programmed this way, it cannot be used for setting (arming) control. Many different codes can be programmed to operate PG outputs, if desired. a keyfob – one button in a pair is used to switch a PG output ON, the second one to switch it off or each of them generates a pulsed switching event. If a keyfob is programmed this way, it cannot be used for setting (arming) control. Each PG output can have as many associated keyfobs as desired. If both buttons

		of the remote control are pressed simultaneously, they will trigger a panic alarm a detector – the PG output copies the status of the detector or it generates a pulsed switching event when the detector is triggered. The detector also effects the control panel which responds with a natural reaction. Only one detector should be programmed to a PG output ON/OFF reaction and should not be combined with keyfob or keypad control as the detector repeats its status every 9 minutes and it would override the signal from the keypad or keyfob.
9	Set/unset	Toggles the system status SET,UNSET,SET,UNSET etc

12.41. Code/card reactions and section assignment

The following sequence programs the features of access codes or cards:

62 nn r s

where: **nn** is the user position from 01 to 50

a	Unsplit system	Split system
0	No event	No event
1	Set all (ABC)	Set all (ABC)
2	Unset all (ABC) *	Unset all (ABC)
3	Set A**	Set A
4	Set AB**	Set B
5	Unset all (ABC) *	Unset A
6	Unset all (ABC) *	Unset B

r is the reaction index from 0 to 9 – see Table 2

s is the section 1 = A, 2 = B, 3 = C (only has an effect in a split system – except for the PG output control reaction)

Guidance on assigning codes or cards to sections:

- In **partial setting (arming) mode** assigning codes or cards to sections has no effect (except for the PG output control reaction). If anything in the system is set and a card/code is used, the system will then be unset, and if all sections are unset then the whole system will be set by a card/code. Partial setting keys A and B on the keypad can be programmed to be followed by a valid access code if required (see 12.13).

- For a **split system, a code assigned to section:**

- A controls section A
- B controls section B
- C controls section A, B and C.

- If the system is not split then the assignment of codes/cards to sections has no effect, but the s parameter must be entered in the programming section. Enter s=3 if splitting is not desired.

Guidance on code/card reactions:

- If a code/card has a natural reaction, i.e. r=1, then its reaction is set,unset,set etc. (the same as reaction r=9 in table 2).
- A code/card can also have an alarm reaction designated to it, similar to detectors.

Factory default setting: all codes/cards from 01 to 50 have a natural reaction (set/unset) and are assigned to section C.

12.42. Enrollment by keying in production codes

This sequence allow the enrollment of devices by keying in their production codes:

60 nn xx..x

where: **nn** is the address of the device from 01 to 50

xx...x is the production code of the device (the last eight digits of the bar code, see the label on the PCB inside the device)

Notes:

- If the address nn is already occupied, the current device will be erased, and the new device will then be enrolled instead.
- If a device with production code xx...x has already been enrolled to another address in the past, and if the device is now enrolled to a new address, then it will be moved to the new address, releasing the old address.
- If you enter nn = 01 or 02, the device will enroll instead of the corresponding hard-wired input in the control panel (the terminal will be disabled).
- If eight zeros are entered as a production code, the device already assigned to the address nn will be erased

12.43. Automatic setting/unsetting schedule

This can be used to program an automatic sequence of daily setting/unsetting events. Up to 10 daily events can be programmed. Events will occur every day of the week:

64 n a hh mm

where:

n is the event number from 0 to 9

a is the type of event from 0 to 6 (see the following table)

hh hours (time of event)

mm minutes (time of event)

Erase the automatic schedule setting by : **64 n 0**

* the same event in an unsplit system

** only possible if partial setting (arming) is programmed (see 12.24)

Notes:

- The automatic setting/unsetting event schedule can also be programmed in maintenance mode.
- If automatic event scheduling is not used for setting/unsetting control and the system is not split, then it **can be programmed as a daily timer** to switch equipment connected to the PGY output on and off at the desired daily times. To do this, split the system (see 12.24) but do not enroll any detectors to section B (keeping this section empty). Then program the PGY output to be triggered by the setting (arming) of section B (see 12.5) and program the automatic daily event schedule (with a=4) to set/unset the empty section B which will then switch the PGY output on and off at the required times every day.

Factory default setting: All automatic events switched off.

12.44. Changing the service code.

To change the service code enter:

5 NC NC

where: NC = new code (4 digits), the new code has to be entered twice

Example- the code 1276 can be programmed by entering: 5 1276 1276

Factory default setting: 8080

12.45. Go to maintenance mode

By entering **292** while in Service Mode the system switches to maintenance mode. In maintenance mode it is possible to program the devices to be bypassed and to adjust the control panel internal clock (see 13.4).

12.46. Setting the internal clock

The control panel has a built in real-time clock which is used to time-stamp all recorded events in the control panel memory. Adjust the clock after installation by entering:

4 hh mm DD MM YY

where:

hh is the time in hours (00 to 23)

mm is the time in minutes (00 to 59)

DD is the day (01 to 31)

MM is the month (01 to 12)
YY is the year (00 to 99)

Note: The internal clock can also be adjusted in maintenance mode.

Example: On 30 June 2012 at 17:15 enter:
 4 17 15 30 06 12

After the control panel is powered up, the clock is set to 00 00 01 01 00.

12.47. Editing keypad text

The names of devices and programmable outputs as displayed on the keypad unit can be edited as follows:

- Pressing and holding the **?** key (in service mode) enters text editing mode and the name of the device enrolled to address 01 is then displayed with a flashing cursor on the first text character.
- Key functions:
 - ▲ and ▼ text scrolling (see table)
 - 1 and 7 character-selection (A,B,C,D.....8,9,0)
 - 4 and 5 cursor control (left/right)
 - 2 delete selected character
 - # exit editing (& save changes)

List of editable text:

text	Description
01: to 50: Devices	Names of devices in addresses 01 to 50
Control panel	Name of control panel (e.g. displayed if its cover is opened)
Keypad	Name of hard-wired keypad
Communicator	Name of the communicator in the control panel
Master code	Name of the master code
01: to 50: Code	Names of user codes
ARC Code	Names of ARC code
Service code	Name of the service code
PGX and PGY	Names of programmable outputs
OASIS JA-80	The default text displayed in operating mode if no other text needs to be displayed. If erased then nothing will be displayed.

Notes:

- Only capital letters can be entered.
- The length of text is limited to the length of the display.
- The text is only stored in the keypad used for editing (different keypads in the system can show different text if desired).
- Text is stored in the non-volatile memory of keypads, so power disconnection will not erase any stored text.
- Convenient text editing is possible using a PC running Comlink software.
- Besides device names, keypads also use so-called internal text such as "service", "maintenance mode" etc, and this text can also be edited via Comlink software by selecting "Settings" on the menu and then "keypad text".
- After editing keypad text using Comlink software, all keypads (including wireless ones) must be connected to the digital bus to save the changes to the keypad units by clicking on the OK button in the software.

Factory default setting: in addresses 01 to 50 there is the text "Device". Other default text: "Control panel", "Keypad", "Communicator", "Master code", users 01 to 50 "Code", "ARC Code", "Service code", "PGX", "PGY" and "OASIS JA-80".

13. Operating the system

The Oasis system can be operated locally using a keypad or a keyfob and it can also be operated remotely by mobile phone or the Internet (if equipped with a suitable communicator).

13.1. The system keypad

Indoor keypads model JA-80F (wireless) or JA-80E (wired) can be used to operate and program the system. Both keypad types provide the same functionality:

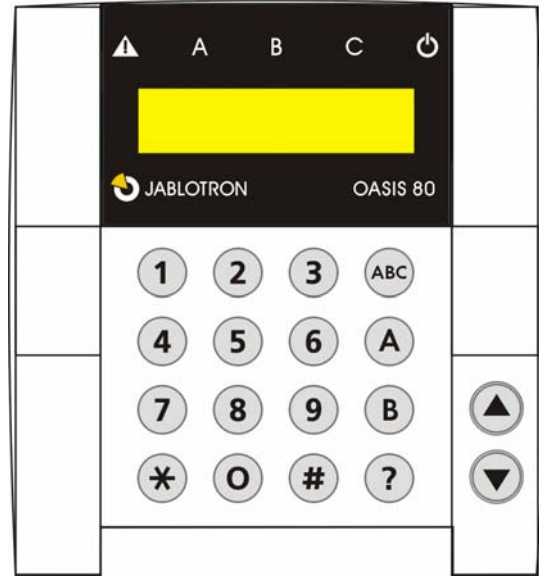

13.1.1. Keypad indicators:

ABC setting (arming) status of sections – if all sections are set then all these indicators (A B & C) are lit.



flashing = alarm, with the simultaneous display of alarm details on the LCD, e.g.:

Alarm
03: Kitchen

constantly lit = fault – details are displayed by pressing the "?" key



power. Constantly lit = mains ok. Flashing = no mains, control panel powered by back-up battery only.

13.1.2. LCD display

The 1st line displays the status: triggered detector, Service mode etc. In standby mode, it shows the text "OASIS JA-80" (editable, see 12.47).

The 2nd line displays the name of a device.(e.g. 01: Main Door etc.). The text can be edited, see 12.47.

Displaying the status of detectors and programmable outputs: Details on permanently triggered detectors (e.g. open windows) and the status of the PGX and PGY outputs can be displayed by pressing the ? key.

13.1.3. Keypad display sleep-mode

In operating mode, the wireless keypad unit displays the system status for 20 seconds (if battery-powered) after the last interaction with a user, and then goes into sleep mode. Pressing any key, triggering the keypad input or opening the keypad's flip cover re-activates the display.

13.1.4. Keys

- 0-9** digital code entry
- *** function sequences
- #** escape
- ABC** hot key for setting the entire system (all sections A, B & C)
- A** hot key for setting section A (e.g. afternoon partial setting of the garage)

- B** **in an unsplit system:** hot key for setting sections A and B (e.g. partial night-setting of the garage and the ground floor).
- in a split system:** hot key for setting section B (C is only set if both sections A and B are set)
- ?** Display of triggered detectors (e.g. open windows), fault details and PGX / PGY status.
- ▲** turning on the PGX output from the keypad (the same effect as *81)
- ▼** turning off the PGX output from the keypad (the same effect as *80)

Notes:

- The A and B keys only have a function if partial setting or splitting are enabled.
- The keys ▲ and ▼ only control the PGX output if they have been programmed for it, see 12.5.

13.1.5. Functions beginning with the * key

The following functions are available to the user via the keypad:

- *1 sets the entire system (the same as key ABC)*
- *2 sets section A (the same as key A)*
- *3 sets A and B, or just B (the same as key B)*
- *4 event memory recall (key 4 scrolls backwards) – the control panel records max. 255 of the latest events
- *5 new Master Code/Card (*5 MC NC NC)
- *6 access code/card programming (*6 MC nn NC)
- *7 for operation while under duress (should be entered before the access code to secretly signal distress)
- *8 PGX control (ON/OFF = *81/*80 or enter *8 to trigger if a pulsed switching reaction is programmed)*
- *9 PGY control (ON/OFF = *91/*90 or enter *9 to trigger if a pulsed switching reaction is programmed)*

- *0 To enter Service Mode (*0 SC – factory default 8080) or to enter maintenance mode (*0 MC – factory default 1234)

The * functions allow the system to be operated from a mobile phone keypad (if the control panel is equipped with the relevant communicator).

13.2. Programming access codes and cards

The system can be controlled by 4-digit codes or by access cards, of the types PC-01 and PC-02 (EM UNIQUE 125kHz standard).

- The control panel has 1 service, 1 master and 50 user codes.
- Only a numerical code can be used as a service code (factory default 8080) – see the control panel programming section.
- The master code** can be a numerical code (factory default 1234) or an access card. Using this master code/card, other users' codes and cards can be programmed or erased. The master code/card is usually used by the system administrator.
- Each user from **01 to 50** can have a numerical code, or a card, or both (factory default: all user codes and cards from 01 to 50 are erased).
- If a user has both a code and a card, then it is possible to program whether both a code and card must be presented to the system for system access, or whether only one of them is required (see 12.37).
- The system does not allow the same code or card to be programmed to multiple users. (if it is desired to move a code/card to another user, the card/code has to be erased from its current user first).
- It is possible to display which code/card positions are already occupied in maintenance mode (see 13.4.1).
- The most convenient way to program codes and cards is by using a PC running Comlink software.
- The control panel allows a maximum of 10 unsuccessful attempts in a row to enter a valid code or card. If exceeded, a tamper alarm starts.

13.2.1. Programming access codes and cards

Abbreviation	Name	Number	Sequence	Notes
SC	Service	1	5 NC NC	<ul style="list-style-type: none"> Only programmable in Service Mode. NC = new code (must be entered twice) – a card cannot be used. Factory-default service code: 8080 This code can be changed but not erased. <i>Example: 5 4567 4567</i>
MC	Master	1	*5 MC NC NC	<ul style="list-style-type: none"> Only programmable if the system is totally unset (disarmed) MC = master code or card (factory default 1234) NC = new code or card entry – a numerical code has to be entered twice, but a card only presented once Either a code or a card can be programmed as a master code (to have both is impossible). The Master Code can be changed but not erased. The Master Code's reaction is set/unset and it is assigned to all sections. To reset the Master Code to the factory default 1234, enter 291 in Service Mode (this will only affect the Master Code). To make handing over the system to the end user easier, we recommend programming the system card (provided with the control panel) to the master code. <i>Example: *5 1234 and then presenting the card to the keypad's RFID reader</i>
UC	User	50	*6 MC nn NC	<ul style="list-style-type: none"> Only programmable if the system is totally unset MC = Master Code or card. nn = user code or card position from 01 to 50. NC = new code or card entry. Factory default: all user codes and cards are erased. Each user position can have both a card and a code programmed to it (by using the sequence *6 MC nn NC twice) Each user code can have its own reaction programmed by an installer in Service Mode, and with a split system, codes can be assigned to different sections. <i>Example: *6 1234 12 4345 (code 4345 will be programmed to user position 12)</i> <p>To erase codes/cards enter:</p> <ul style="list-style-type: none"> *6 MC nn 0000 erases the code and the card in user position nn. *6 MC 00 UC erases the code UC (or card UC) if programmed to any user position. *6 MC 00 0000 erases all user codes and cards in user positions 01 to 50.

13.3. Setting and unsetting (arming/disarming) the system

The system can be set and unset from a keypad, a keyfob or remotely by phone or the Internet or from a PC running Comlink software.

To set the system from a keypad:

- Press key ABC, A or B,
- Enter a code (or present a card)
- If the system is partially set (section A is set), and you wish to extend the proportion of the system which is set, press the B or ABC key. If you extend the proportion of the system which is set, then all delayed or next-delayed detectors in the section(s) going to be set and in the section currently set, will provide an exit delay which means that if a user has his system partially set (e.g. night setting) and wishes to exit the house by walking through the sections that are still set, he will not need to unset the whole system before leaving the house and setting the whole system. The route used by the user to leave the house must be covered by delayed or next-delayed detectors to make this possible and must be considered at the system design stage.

To unset the system from a keypad:

- Enter a valid access code (or present a card).

Operating the system from an outdoor keypad

If the system is equipped with a JA-80H outdoor keypad or a JA-80N external card reader then the outdoor device could either work the same way as an indoor keypad unit or it could be programmed only to operate an electric door lock (known as an outdoor-bypass feature), i.e. an indoor keypad would then be used to control the alarm system. If the outdoor-bypass feature is enabled then:

- Setting and unsetting the alarm system is only possible using a JA-80F or JA-80E indoor keypad or a keyfob.
- Entering a valid access code or presenting a valid card to the outdoor keypad or card reader will always only open the electric door lock.
- If the system is set, and the door is opened via the outdoor keypad or reader, an entrance delay will begin. During this delay the system has to be unset using an indoor keypad unit (or keyfob).

13.4. Maintenance Mode

Maintenance mode can be entered using a master code or master card by entering:

***0 MC**

where MC = master code (card) – factory default 1234

In maintenance mode it is possible to:

- Test devices (an alarm cannot be triggered),
- Display which code/card positions are currently occupied
- Bypass individual devices (for one setting/unsetting cycle or indefinitely) - see 13.4.2.
- Program the real-time system clock – see 12.46.
- Program the automatic setting/unsetting schedule – see 12.43.
- Program telephone numbers for event reports to the end user (see 12.6).
- **Exit maintenance mode by pressing the # key.**

13.4.1. Displaying which user/card positions are occupied

Which positions in the range 01 to 50 are occupied by codes or cards can be displayed in maintenance mode as follows:

1. The control panel must be in maintenance mode – if not then enter *0 master code or card (factory default: 1234) while the system is totally unset.
2. Press key **5** (the display indicates “Codes 01: Code”),

3. Using the arrow keys all user positions (01 to 50) can be scrolled through, with the A indicator showing whether a code is programmed or not, and the B indicator showing whether a card is programmed or not.
4. To exit this code/card display mode press the **#** key.
5. To exit maintenance mode press the **#** key.

To change access codes and cards use sequence ***6 MC nn NC** (see 13.2).

The most convenient way to administer codes is by using a PC running Comlink software.

13.4.2. Bypassing devices

In maintenance mode it is possible to bypass (disable) individual system devices (permanently or only for one setting/unsetting cycle):

1. The control panel must be in maintenance mode – if it is not, then enter *0 master code (factory default: 1234) while the system is totally unset.
2. **Press key 1**, to display the control panel's **bypass menu**.
3. Using the arrow keys you can scroll through all the devices able to trigger alarms.
4. **To bypass** a device use key:

2 to bypass the device for one setting/unsetting cycle (the triangular indicator will start flashing)

3 to permanently bypass a device (the triangular indicator will light continuously)

To cancel the bypassing of a device use the same button as was originally used for bypassing (**2** or **3**). Using key **4** will cancel all device bypasses in the system.

5. All the desired bypasses can be programmed by repeating step 3 and 4.

6. Press the **#** key to exit the bypass menu. Pressing **#** again exits maintenance mode.

If a system with bypasses programmed is being set, then bypass text will be displayed on the keypad unit.

13.4.3. Protecting a car near the system

The Oasis system can also protect a car (cars) parked in the proximity of the house.

1. If the car has a built-in car alarm then an RC-85 transmitter unit can be connected to the car alarm output and the transmitter unit can be enrolled to a free address in the Oasis control panel. An alarm triggered in the car can be indicated as an Oasis panic alarm 24 hours a day whether the system is set or not. Note: if the car alarm confirms setting (arming) by siren chirps appearing on the alarm output, then these should be disabled to avoid false alarms.

2. **If the car has no built-in car alarm** then JA-85P or JA-85B detectors can be installed in the car. The car detectors can be assigned to their own dedicated section in the system, e.g. a split system where section A could be for the car detectors, and section B for the house detectors, with no detectors assigned to section C, and the entry codes/cards assigned to section C to access the whole system. So when the user enters the house he can set section A to protect the car, and unset section B to be able to enter the house. Radio communication supervision should be disabled for the car detectors to avoid fault notifications when the car is driven away from the house.

14. Operating and programming the system by PC

The Oasis system can be operated and programmed locally using a PC running Comlink software. To connect the control panel to the PC use a JA-80T interface or a JA80-BT wireless Bluetooth interface.

Comlink software can be used by installers and end users. The software only allows access to features allowed by the access code (service or user).

If the control panel is equipped with a suitable communicator such as the JA-80Y (GSM/GPRS) or JA-80V (LAN/Telephone line) then the system can also be accessed from a PC connected to the Internet. For this remote access it is first necessary to register at www.GSMLink.cz

15. Basic guidance for installers

1. Create an installation plan that sufficiently covers the building to be protected.
2. If the customer requests changes to the suggested configuration, especially reducing the number of detectors, ask for his request to be given to you in writing to avoid future disputes.
3. Perform the installation in a very professional and conscientious manner and always tidy up the site afterwards.
4. It is very important to teach the end user how to use and test the system and to check his level of understanding.
5. Get the customer to sign a written statement that the system was installed according to the customer's specifications and that the customer understands how to operate the system.
6. Explain the importance of the annual technical inspection of the system and offer him this service. For more details see the relevant EN standards.

16. Trouble-shooting

Problem	Possible causes	Solutions
The control panel is not in service mode after being powered up.	The control panel does not have factory-default settings.	Reset the control panel.
It is impossible to enroll a wireless device to the control panel.	The device's location is unsuitable, the control panel antenna is disconnected, the device's battery was incorrectly installed, the control panel is not in enrollment mode, the device is too near to the control panel (it should be at least 2 meters away).	Check and fix it.
The keypad unit indicates a fault	Press the ? key to see the cause.	React according to the cause displayed.
A motion detector triggers false alarms for no apparent reason.	Animals are moving in the protected area (mice etc), sudden changes in temperature, significant air movements, movement of objects having a temperature close to 37°C (e.g. curtains moving above a radiator)	Change the location of the detector, select a higher immunity in the detector, use an optional pet lens in the detector, program alarms confirmed by two detectors in the control panel.
The wireless keypad does not indicate entrance delays by beeping.	If the keypad is only battery-powered, then it turns off 20 seconds after the last time a key was pressed. To indicate entrance delays, first wake it up.	Install an ordinary magnetic sensor to the entrance door, wiring it to the keypad input so that opening the door wakes up the keypad and reports to the control panel. Alternatively, power the keypad with an AC adaptor to prevent sleep mode or install an indoor wireless siren type JA-80L to generate entrance delay beeps.

17. Control panel technical specifications

Power supply	230 V / 50 Hz, max 0.1 A, CLASS PROTECTION II
Backup-battery	12 V, 1.3 or 2.2 Ah, typical battery lifetime approx. 5 years
Backup power output	maximum continuous load 0.4 A, intermittent load 1 A for 15 min's max.
Number of wireless device addresses	50
Number of hard-wired inputs	2, double balanced inputs, with triggering and tamper functions, programmable section assignment and reactions
External warning output EW*	switchable relay contact max. 1A/60V
Internal warning output IW*	switching to GND, max. 0.5A
Programmable outputs*	PGX, PGY max. 0.1 A, switching to GND, programmable function
Event memory	255 latest events, including date and time stamping
Communications frequency	868 MHz
Security grade	2 according to EN 50131-1, EN 50131-6, and EN 50131-5-3
Operating environment	II. internal (-10 to +40°C) - compliant with EN 50131-1
Radio emissions	ETSI EN 300220
EMC	EN 50130-4, EN 55022
Electrical safety	EN 60950-1
Can be operated according to	ERC REC 70-03

* these signals are also transmitted wirelessly to AC and UC receiver modules.



Jablotron Ltd. hereby declares that the JA-80K is in compliance with the essential requirements and other relevant provisions of Directive 1999/5/EC. The original of the conformity assessment can be found at www.jablotron.com, Technical Support section.



Note: Although this product does not contain any harmful materials we suggest you return the product to the dealer or directly to the producer after use.

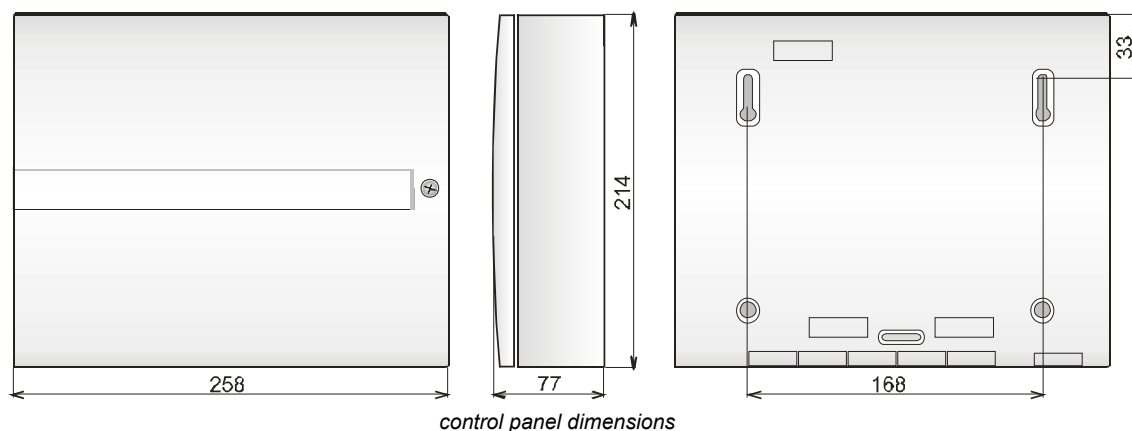

Jablotron Ltd., Pod Skalkou 33
466 01 Jablonec nad Nisou
Czech Republic
Tel.: +420 483 559 911
fax: +420 483 559 993
Internet: www.jablotron.com