

The SD-503ST Stand-alone combined smoke and heat detector

The SD-503ST is used to detect fire hazards in the interior of residential or commercial buildings. The detector can be installed in mobile homes or caravans. The product is not designed to be installed in industrial premises.

The detector indicates a fire hazard using the built-in LED indicator and acoustic signalling.

The SD-503ST consists of two independent detectors – an optical smoke detector and a heat detector. The optical smoke detector works on the principle of scattered light. It is very sensitive to large dust particles which are present in dense smoke. It is less sensitive to smaller particles generated by the combustion of liquids such as alcohol. That is why the fire detector also contains a built-in heat detector which has a slower reaction but is much better at detecting fire which generates only a small amount of smoke.

Detector range and location

The smoke detector must be installed so that any smoke easily drifts into the detector owing to natural thermal currents, e.g. on the ceiling. It is suitable for residential buildings but not suitable for free spaces, outdoor environments or interiors with extremely high ceilings (above 5 m) where fire by-products can disperse over a large area – the smoke would not reach the detector position.

The detectors should be installed by a trained technician with a valid manufacturer's certificate.

Detectors should be installed in the building according to the project documentation. If such documentation is not available, the detector positions should comply with the effective standards for fire alarm signalling systems.

The detector must always be placed in the section leading to the exit of the building (escape route), see Fig. 1. If the building has a floor area greater than 150 m², installation of an additional detector in some other suitable place is required, see Fig.2.

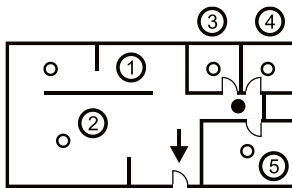

Fig 1

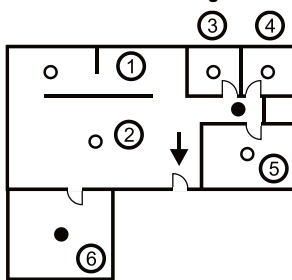

Fig 2

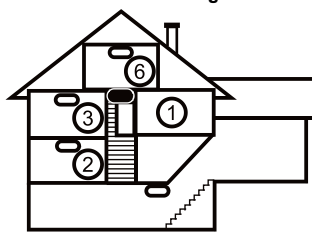

Fig 3

In multi-storey flats and family houses the detector should be installed above the stairs. It is recommended to place additional detectors in rooms where people sleep. See Fig 3.

Installation on level ceilings

Place the detector in the centre of the room if possible. **The detector must not be recessed into the ceiling** due to the possible existence of a cool air layer on the ceiling. **Never place the detector in the corner of the room** (always keep at least 0.5 m distance from the corner - see Fig 4). There is an insufficient circulation of air in the corners.

Installation on sloping ceilings

If the ceiling is not suitable for mounting on a level surface (e.g. a room under a roof ridge), the detector can be installed as in Fig. 5.

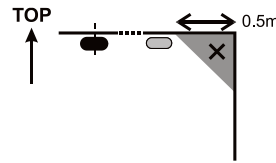

Fig. 4

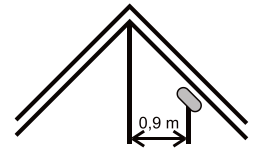

Fig. 5

- centre of the room, best location
- acceptable location

Walls, partitions, barriers and lattice ceilings

The SD-503ST detector must not be installed closer than 0.5 m from any wall or partition. A narrow room with a width of less than 1.2 m requires the detector(s) to be placed at a distance of at least one third of the room's width away. In a case when a room is separated into sections with furniture, racks or semi partition walls which do not reach the ceiling, the space is considered to be fully separated if the gap between the top of these and the ceiling does not exceed 0.3 m. A free space of at least 0.5 m is required under and around the detector. Any irregularities of the ceiling (e.g. girders) exceeding 5 % of the ceiling height should be considered a wall and the above mentioned limitations should apply.

Ventilation and air circulation

The detectors must not be installed directly by ventilation or air conditioning vents. In the case of air being supplied through a perforated ceiling, each detector must be placed so that no perforation hole occurs within 0.6 m of the detector.

• Avoid installing the detector in the following locations:

- places with poor air circulation (niches, corners, apexes of A-shaped roofs, etc.)
- places exposed to dust, cigarette smoke or steam
- places with over-intense air circulation (close to ventilators, heat sources, air conditioning outlets, etc.)
- in kitchens and other cooking places (because steam, smoke or oily fumes can cause false alarms or reduce detector sensitivity).
- beside fluorescent lights or energy-saving light bulbs (electrical interference can cause a false alarm)
- in areas with lots of small insects

Warning: Most false alarms are caused by improper detector location.

See CEN/TS 54-14 standards for detailed installation guidelines.

Installation

When installing the detector, abide by the procedures recommended in the previous paragraphs.

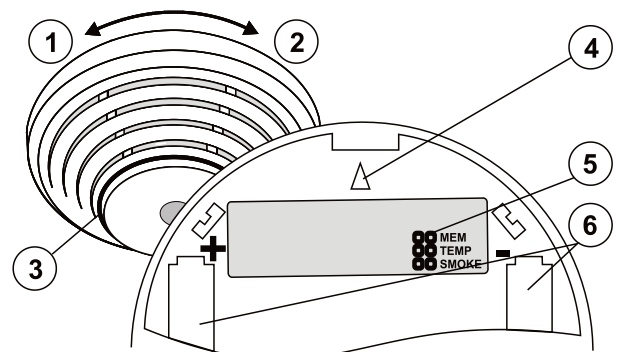



Fig. 6: 1– detector cover opening; 2 – detector cover closing; 3 – optical status signalling (red LED); 4 – arrow showing where to insert the detector; 5 – configuration terminals; 6 – battery holders;

1. Open the detector cover, by turning it anti-clockwise (1)
2. Attach the plastic base to the selected place using screws
3. Use the terminals (5) to set the required detector function – see the table below

1	ON	Memory disabled	2	OFF	Smoke (EN 14604) or heat (EN 54-5)
	OFF	Memory enabled	3	OFF	
			2	ON	Heat only (EN 54-5) (no smoke)
			3	OFF	
			2	OFF	Smoke only (EN 14604) (no heat)
			3	ON	
			2	ON	Smoke and heat at the same time (both conditions concurrently)
			3	ON	

When the detector is installed in caravan trailers, use only the “smoke only” or “both smoke and heat” settings.

4. **Insert the batteries (3 X AA, alkaline 1.5 V)**
5. **Close the detector cover.** The detector can be inserted into the plastic base in one position only. The correct position is marked with arrows on both plastic parts (4).

Note: Detector cover closing is blocked unless all 3 batteries are inserted!

The mounting base must not be replaced by bases meant for detectors without the test button consisting of pressing the body of the detector.

Fire alarm

A fire alarm is signalled both acoustically and optically.

When the conditions for fire alarm triggering are met (smoke is detected in the room, the alarm temperature is reached, or both), the detector signals the danger by sounding the siren and quickly flashing the LED indicator (3).

Silencing the siren during an alarm: The siren can be silenced by pressing the detector body against the base. The siren is then silent for 10 minutes. If the detector still detects smoke or heat then, the siren is reactivated.

When the need arises (e.g. in the case of a detector failure), it is possible to postpone siren reactivation by up to 12 hours. This can be done by pressing the detector again for 5 s after silencing the siren. When the detector chirps, you have to release the pressure within 1s. The switchover to the postponed siren mode is confirmed with 5 chirps. The detector LED flashes all the time during the postponement.

Alarm memory: If it is enabled, alarm indication continues even when the smoke clears or when the temperature decreases. The slow-flashing indication lasts 24 hours unless it is terminated by pressing the detector body.

Detector testing

The detector should be tested at least once per month. To test the detector press its body against the base and wait until the LED indicator starts flashing. The LED flashing signals switchover to test mode. The LED flashes for the whole duration of the test. When the test is complete, the LED switches off. The detector then signals the result. If the detector chirps once, no problems have been detected. If a fault is discovered, the LED flashes three times. The detector flashes once without acoustic indication if the test is finished and a low battery is detected. If the battery is low, there is no acoustic signalling.

The complete function of the detector can be tested with a testing spray (e.g.. SD- TESTER) or hot air (e.g a hair dryer).

Warning: never test the detector with fire.

Fault indication

The detector checks its functioning. If it discovers a fault, it beeps and flashes three times simultaneously, and then flashes three times every 30 s.

A detector test can be carried out when a fault is signalled. To test the detector, press its whole body against the base. During test the detector checks whether the fault still exists. The LED flashes during the testing. When the test is completed, the LED stops flashing and then signals the result. A persistent fault is signalled by 3 flashes and 3 beeps. If the fault has been removed, the detector chirps briefly.

If you have not managed to repair the fault, the detector must be sent to a service centre.

Battery replacement

The detector checks the battery status and if the batteries are running low, the detector signals that they need replacing by short flashes every 30 s. Replace the batteries as soon as possible. Always replace all three batteries with the same type and manufacturer.

Note: For the best possible operation we strongly recommend using only batteries supplied by Jablotron's authorized distribution (avoid usage of so called no-name batteries).

Do not throw used batteries into ordinary household waste. Deposit them at authorized collection points.

Technical specifications

Power	3 x alkaline batteries AA (LR6) 1.5 V
	Please note: Batteries are not included approx. 3 years
Typical battery lifetime	optical light scattering
Smoke detection	Smoke detector sensitivity $m = 0.11 - 0.13$ dB/m pursuant to EN 14604:2005
Heat detection	class A1 according to EN 54-5
Alarm temperature	+60 °C to +65 °C
Operating temperature range	-10 °C to +65 °C
Dimensions, weight	diameter 126 mm, height 52 mm, 150 g
Conformity	EN 50130-4, EN 55022



1293-CPR-0390

JABLOTRON ALARMS a.s. hereby declares that the SD-503ST detector is in compliance with the essential requirements and other relevant provisions of Regulation 2011/305/EU, 2011/65/EU and Directive 2004/108/EC. The original of the conformity assessment can be found at www.jablotron.com - Technical Support section



Note: Although this product does not contain any harmful materials we suggest you return the product to the dealer or directly to the producer after use. For more detailed information visit www.jablotron.com.

JABLOTRON
CREATING ALARMS

JABLOTRON ALARMS a.s.
Pod Skalkou 4567/33
46601 Jablonec nad Nisou
Czech Republic
Tel.: +420 483 559 911
Fax: +420 483 559 993
Internet: www.jablotron.com